



AN INTRODUCTION TO IMMUNOLOGY

Paul Thomas

Unit 1

Department of Immunology

St. Jude Children's Research Hospital

CATEGORIES OF PATHOGENS

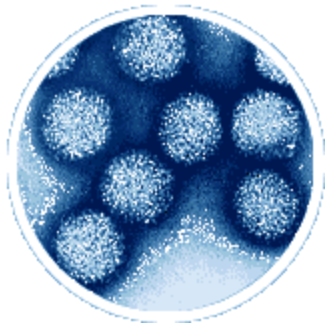

Viruses (~0.2 microns)

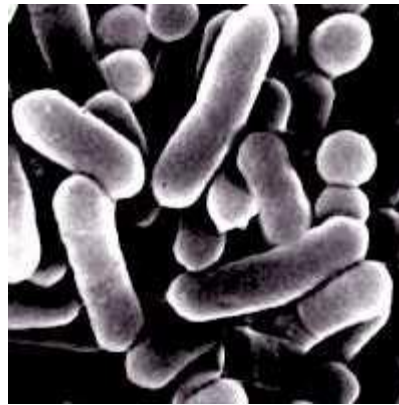

Bacteria (1-2 microns)



Parasites (Millimeters)



PATHOGEN LIFESTYLES

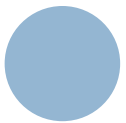
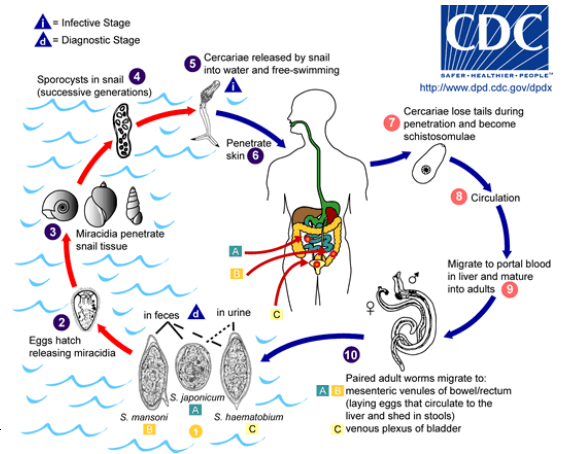
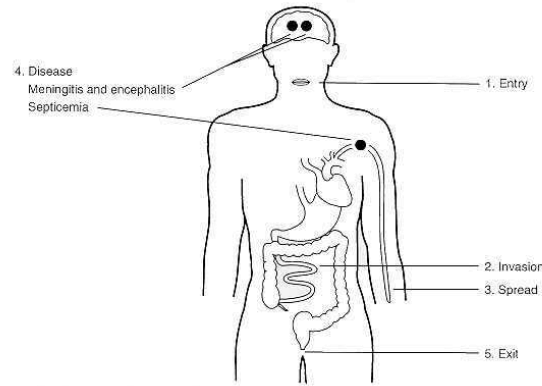
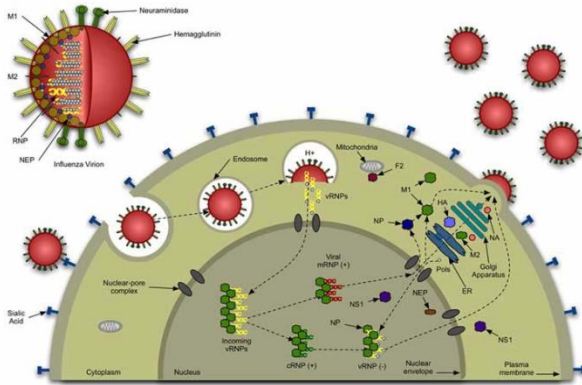

“QUESTIONS” ANSWERED BY THE IMMUNE SYSTEM

- When should I respond?
 - Is this infectious (not self)?
 - Is this a threat?
- How should I respond?
 - What’s the most effective means of control?
 - How do I limit damage?



IMMUNOLOGICAL THEMES

- Generalized inflammation followed by a specific, pathogen-directed response
- Communication via soluble mediators—cytokines and chemokines
- Feedback regulation to limit hyperinflammatory responses
- Multiple modes of recognition and specificity determination
- NOT centrally organized
- Not always clear what is essential, what is redundant, and what is irrelevant



PATHOGEN-SPECIFIC APPROACHES

- Some pathogens must be eliminated for host survival—usually small, rapidly growing, with limited genomes
 - Primary goal is to win a race—grow quickly enough to transmit before host death or clearance
 - No sophisticated “biosensing” apparatus
 - Viruses like influenza, ebola, RSV
- Some pathogens are acute or chronic depending on the host situation
 - Usually more complicated
 - Host genetic and environmental factors might determine susceptibility and permissiveness for chronic vs. acute infection
 - Bacteria (TB) and viruses (HCV)
- Some pathogens are almost exclusively chronic
 - Sophisticated genomes, large size (but not always)
 - Not fully understood in every circumstance—host may simply not have a mechanism for effective clearance
 - Usually not acutely lethal
 - Parasitic worms, HIV



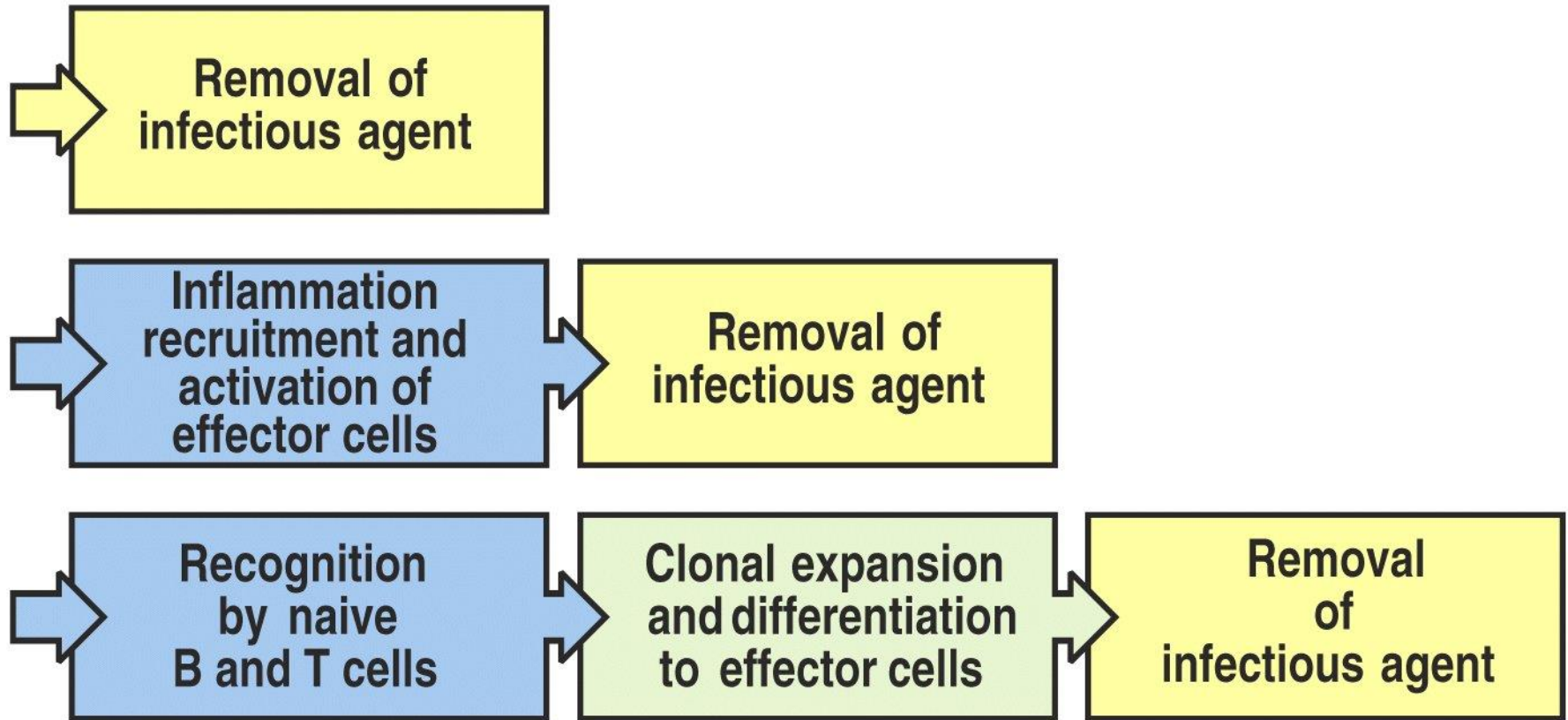

Figure 2-1 part 2 of 2 Immunobiology, 6/e. (© Garland Science 2005)



STAGES OF AN IMMUNE RESPONSE

- Physical prevention of infection (skin, mucus, surfactants, cilia beating)
- Innate epithelial inflammation (defensins, interferons)
- Professional innate cell recruitment (phagocytosis, amplification of direct effectors, including defensins and reactive oxygen species)
- Generation of adaptive response and clearance by antibody, CD8 T cell killing or CD4 T cell modulation of environment (either extracellular or intracellular)



Innate immunity
(rapid response)

Adaptive immunity
(slow response)

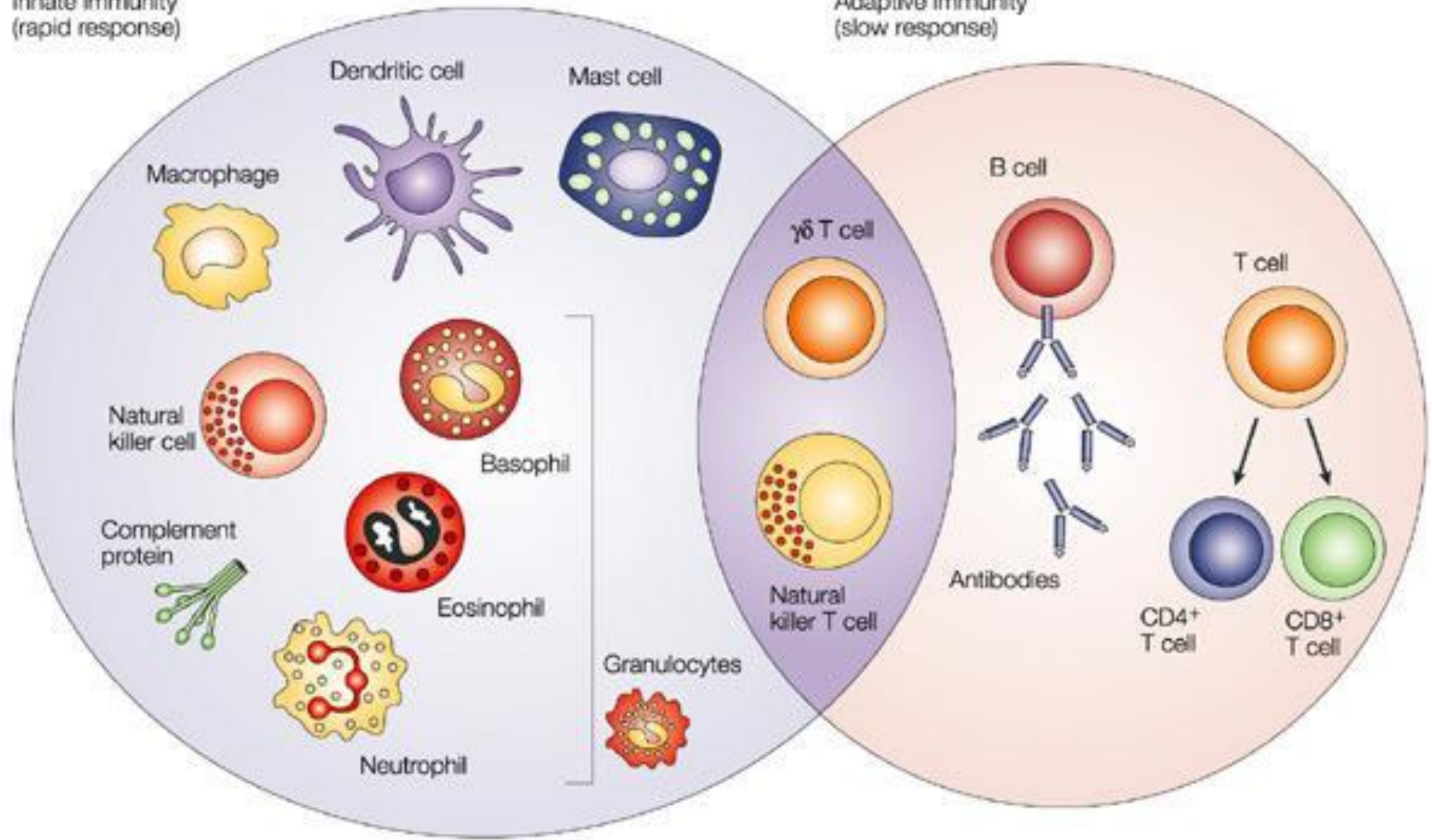

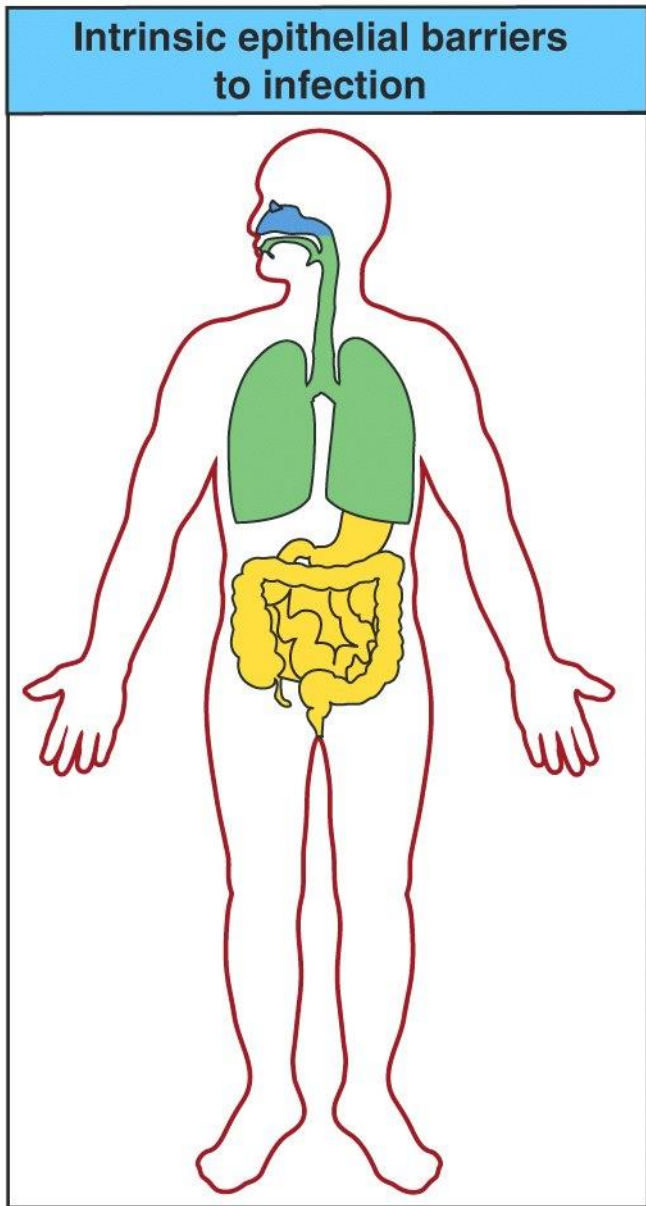

	Skin	Gut	Lungs	Eyes/nose
Mechanical	Epithelial cells joined by tight junctions			
	Longitudinal flow of air or fluid		Movement of mucus by cilia	
Chemical	Fatty acids	Low pH		Salivary enzymes (lysozyme)
		Enzymes (pepsin)		
	Antibacterial peptides			
Microbiological	Normal flora			

Figure 2-4 Immunobiology, 6/e. (© Garland Science 2005)

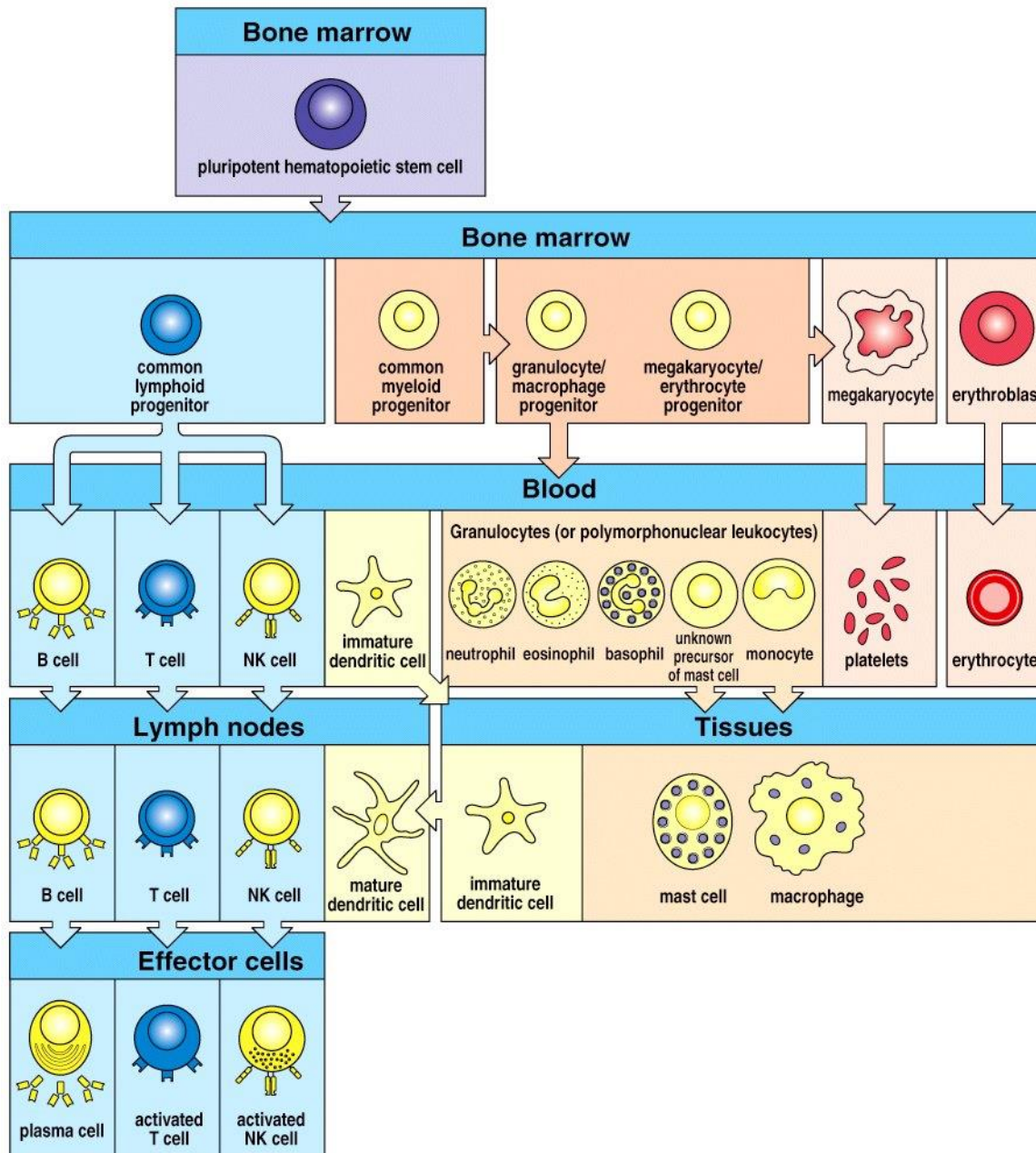
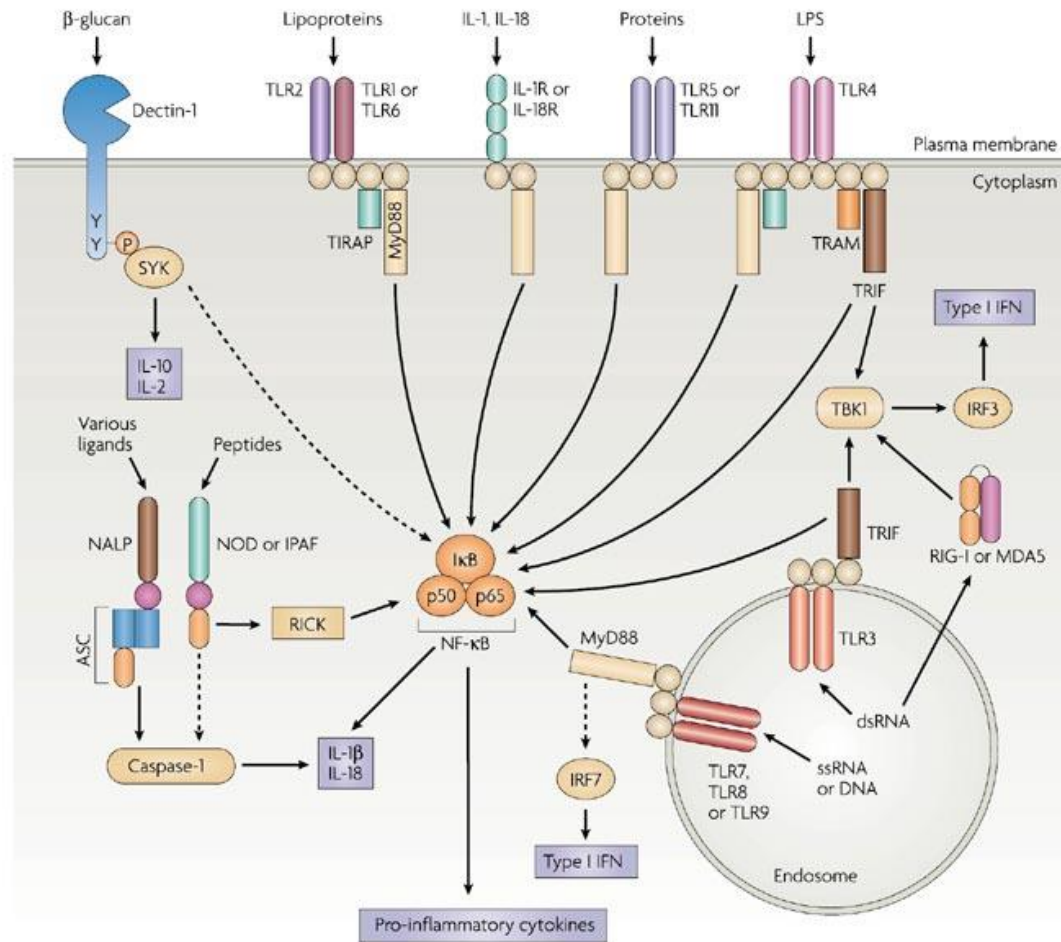
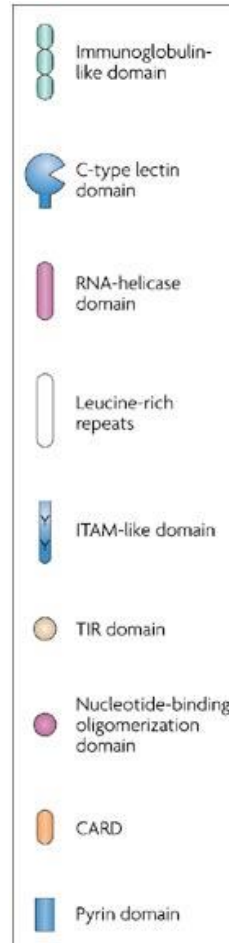

Figure 1-3 Immunobiology, 6/e. (© Garland Science 2005)

INNATE IMMUNE PATTERN RECOGNITION

- Initial responses mediated by three major families of innate receptors: TLRs, RLRs, and NLRs
- TLR: cell surface or endosomal
- NLR and RLR: cytoplasmic
- All 3 activate distinct, but overlapping, host response pathways



EXPANDING COMPLEXITY

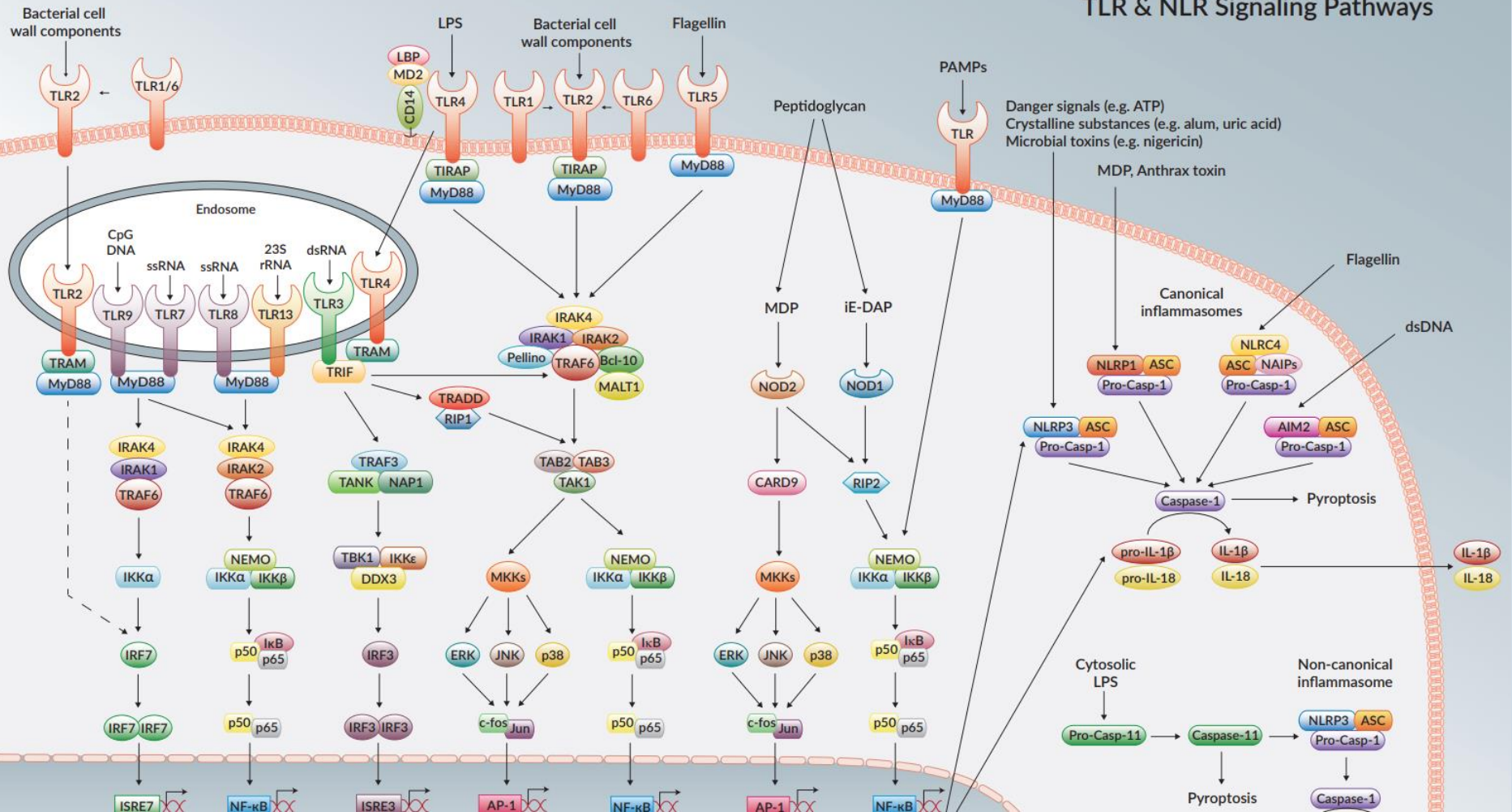

UNCONVENTIONAL NUCLEIC ACID RECOGNITION

CLR, RLR & CDS Signaling Pathways

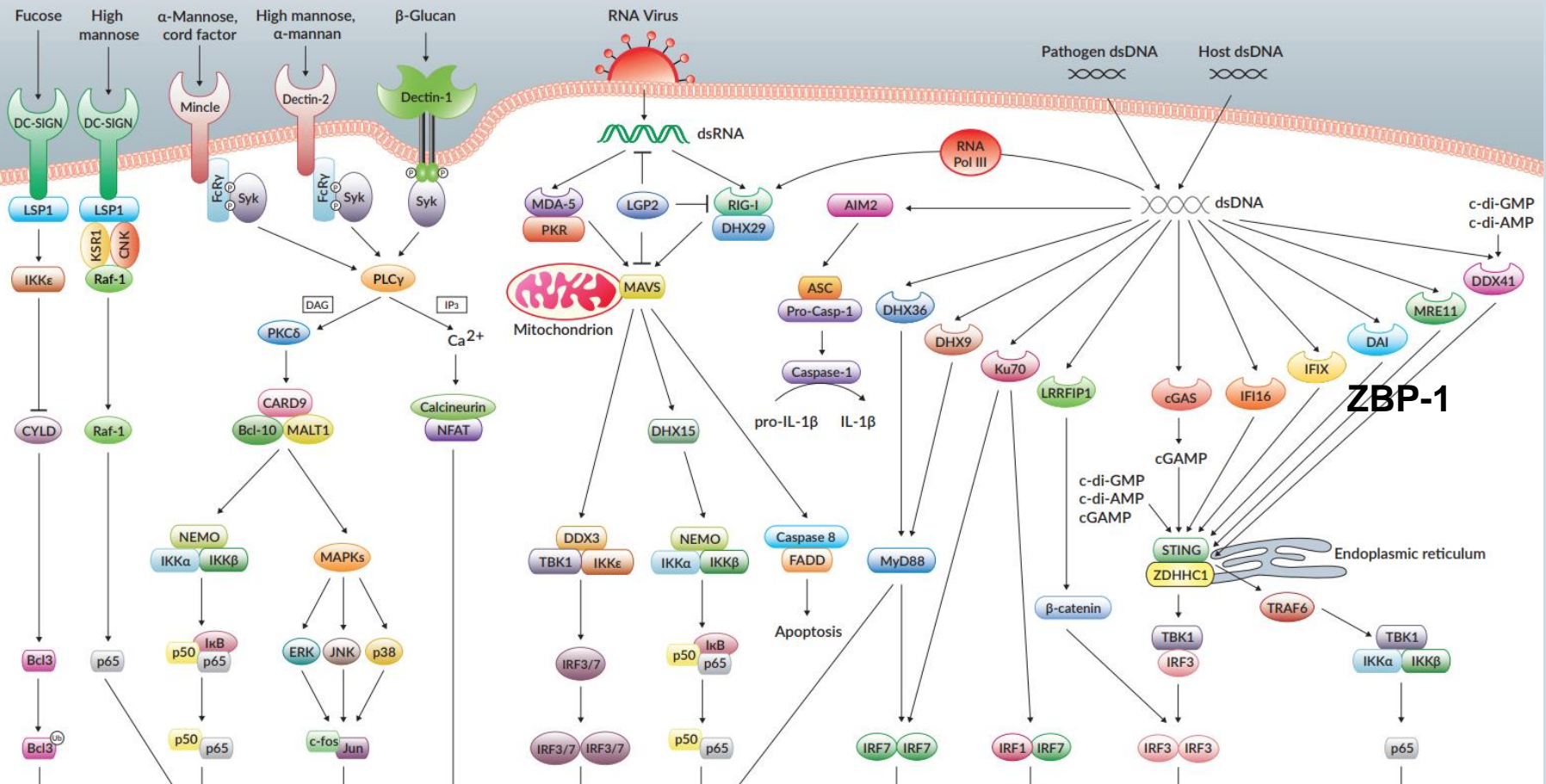

Virus-infected host cells

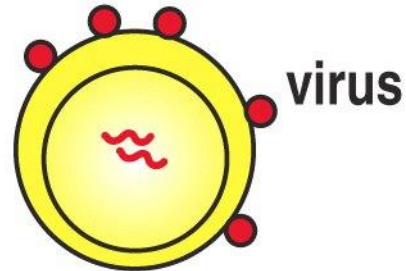

IFN- α , IFN- β

Induce resistance to viral replication
in all cells

Increase MHC class I expression and
antigen presentation in all cells

Activate NK cells to kill virus-infected cells

Figure 2-48 Immunobiology, 6/e. (© Garland Science 2005)

EFFECTOR MECHANISMS OF THE INNATE RESPONSE: DIGESTION AND CHEMICAL DESTRUCTION

- Innate activation can lead to direct killing by a phagocytic cell engulfing the pathogen
- Chemical destruction occurs after acidification of the phagosome by endosomal fusion
- Reactive oxygen and nitrogen intermediates (ROI and RNI) are also effective mediators of pathogen killing—all components available internally in innate cells

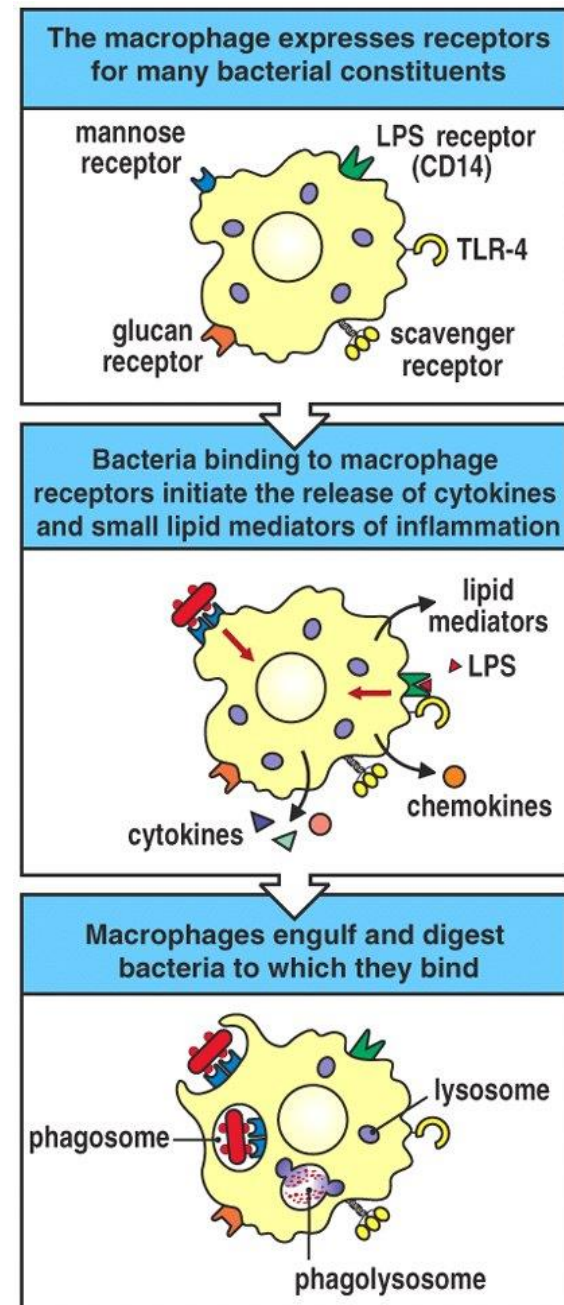

Figure 2-5 Immunobiology, 6/e. (© Garland Sci

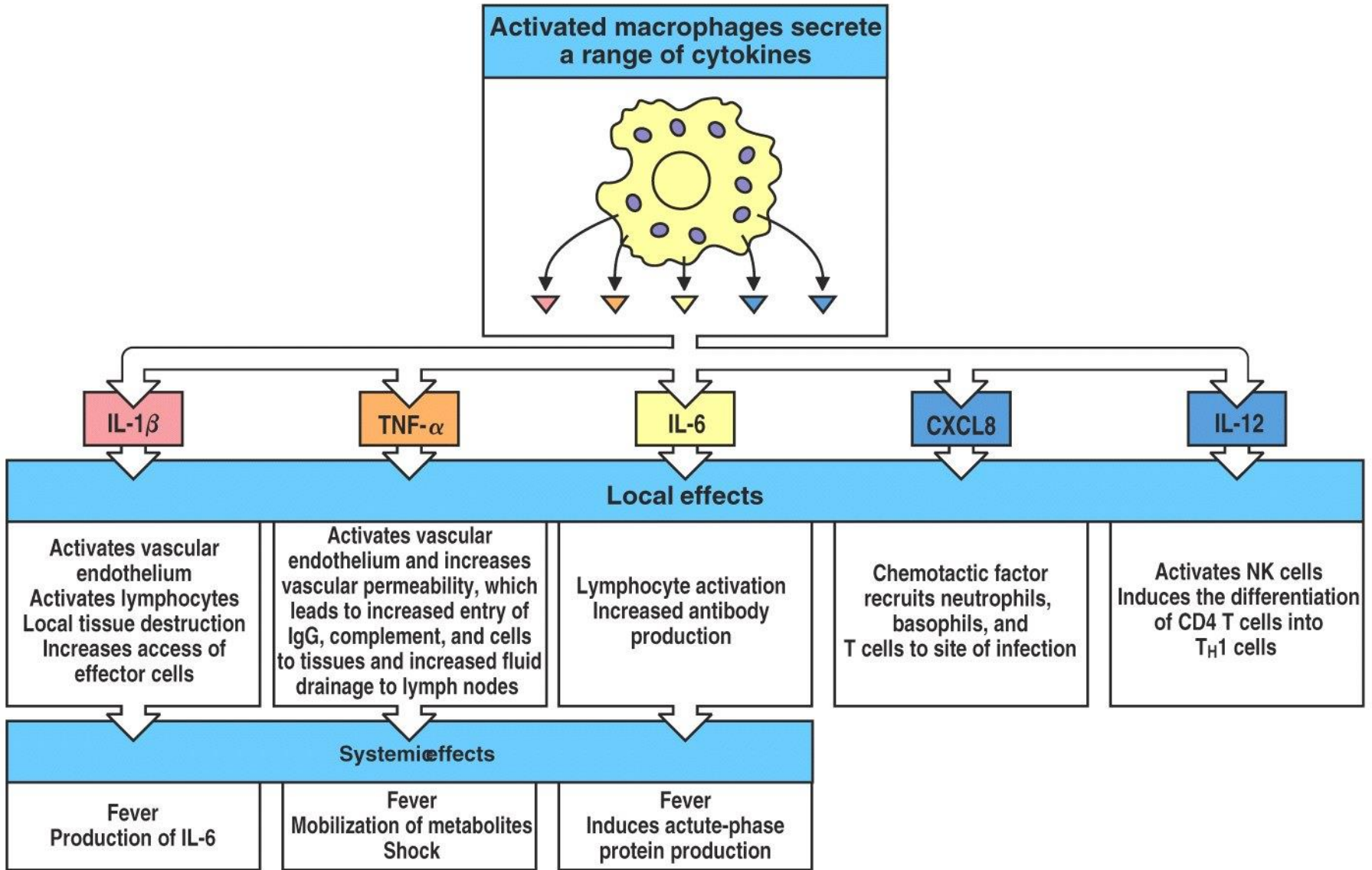

Figure 2-39 Immunobiology, 6/e. (© Garland Science 2005)

Monocyte binds adhesion molecules on vascular endothelium near sites of infection and gets chemokine signal

The monocyte migrates into the surrounding tissue

Monocyte differentiates into a macrophage and migrates to the site of infection

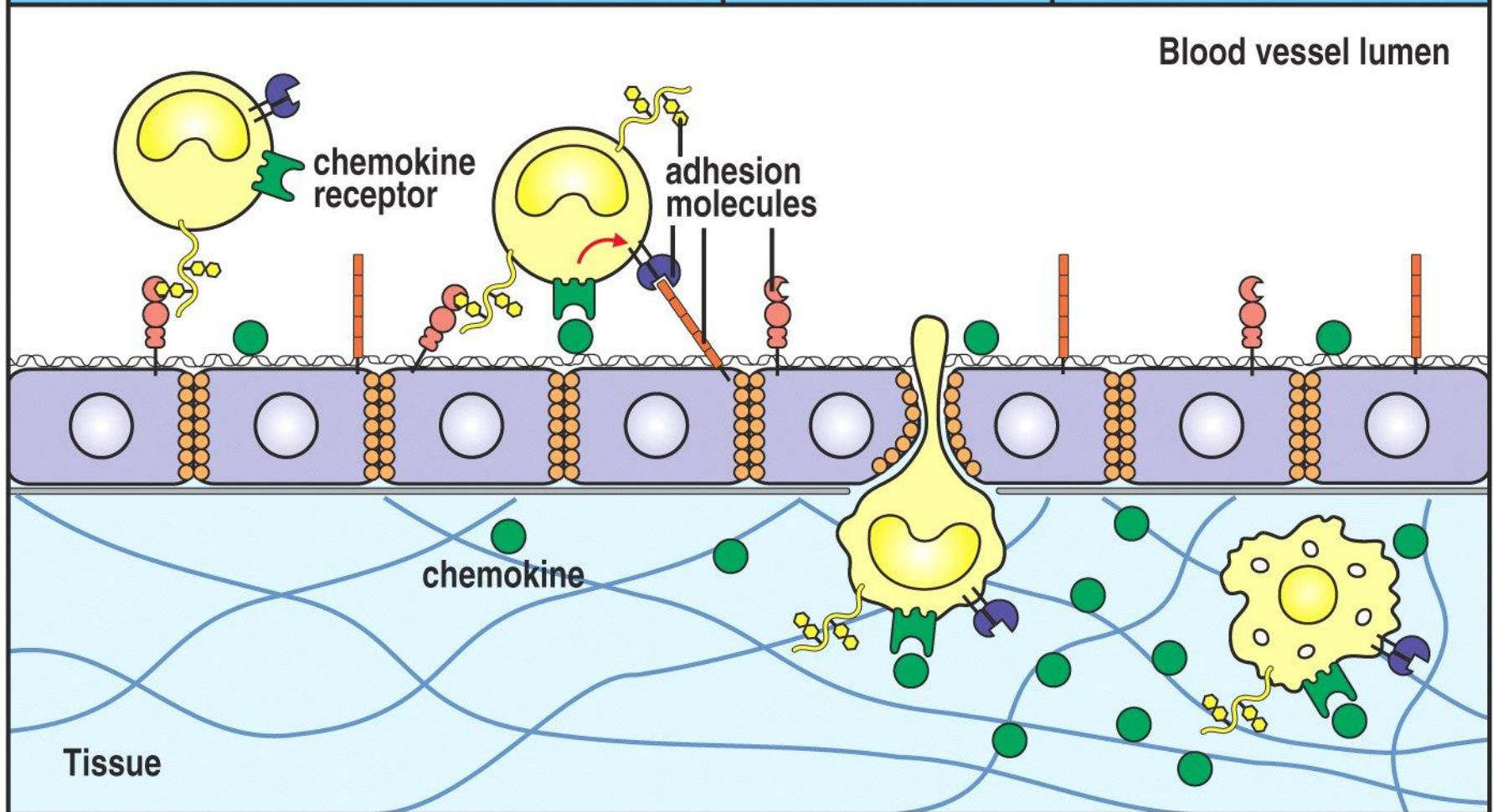

Figure 2-9 Immunobiology, 6/e. (© Garland Science 2005)

EFFECTOR MECHANISMS OF THE INNATE REPOSE: COMPLEMENT

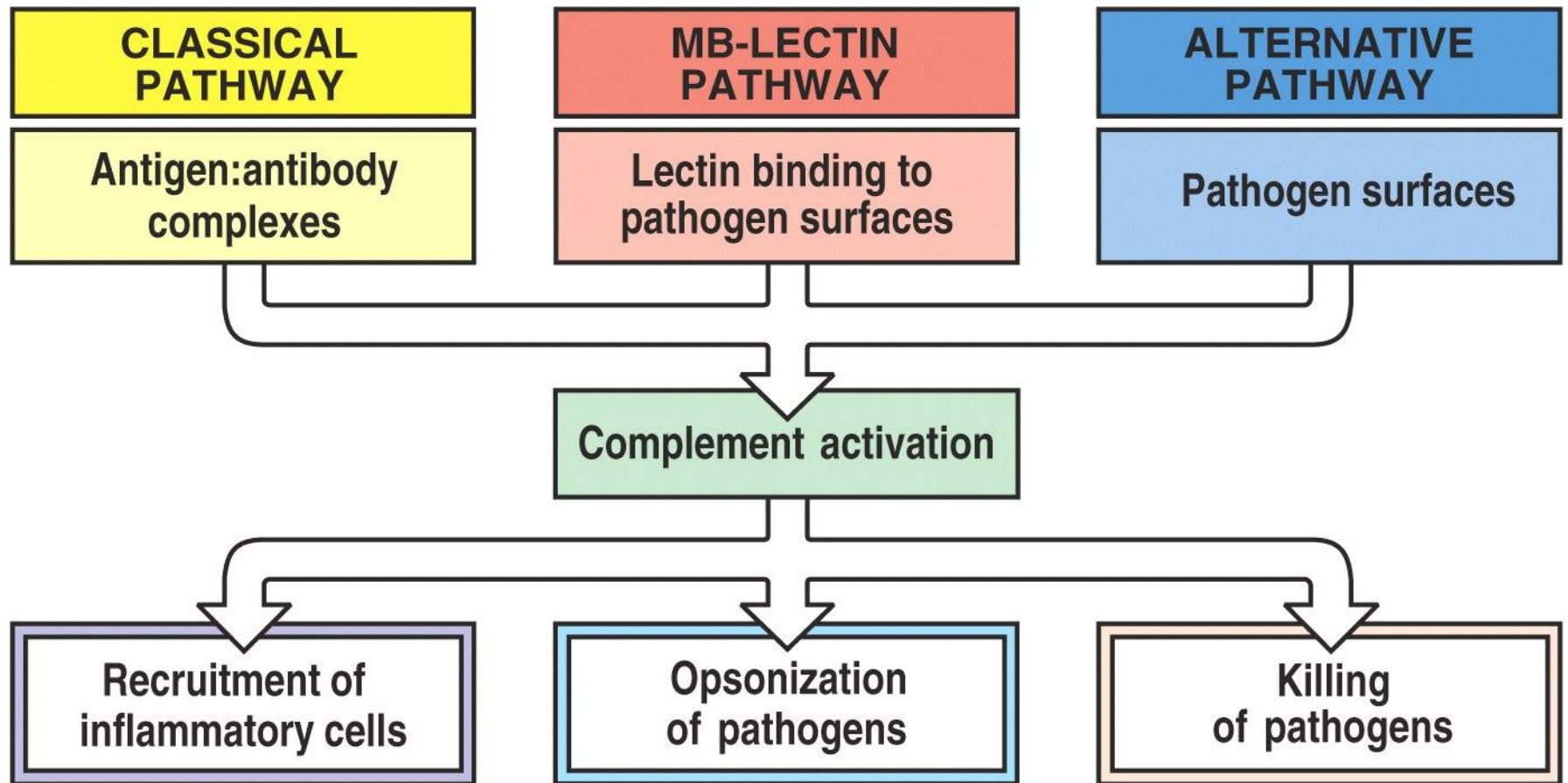

Figure 2-18 Immunobiology, 6/e. (© Garland Science 2005)

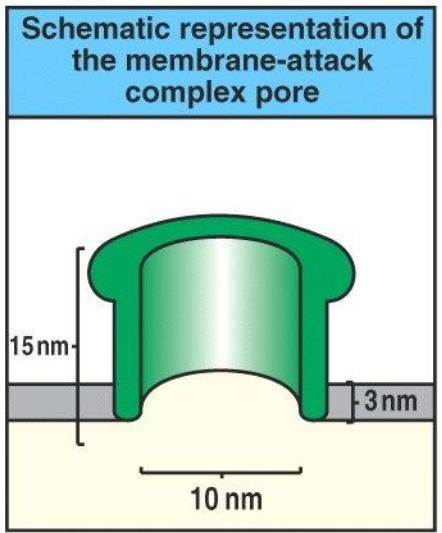
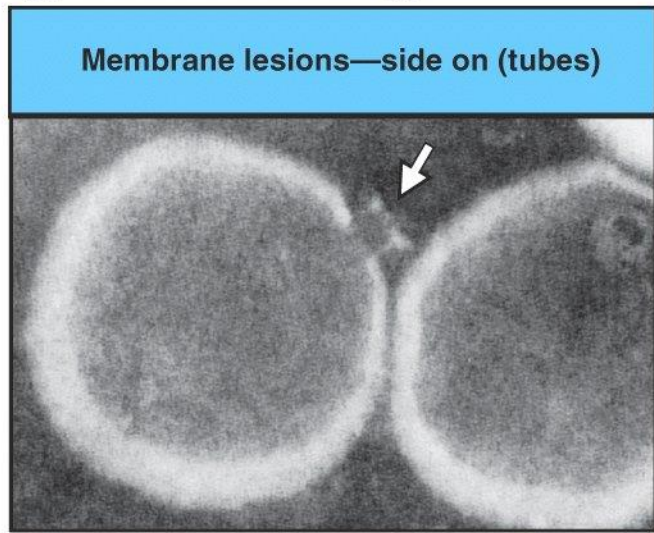
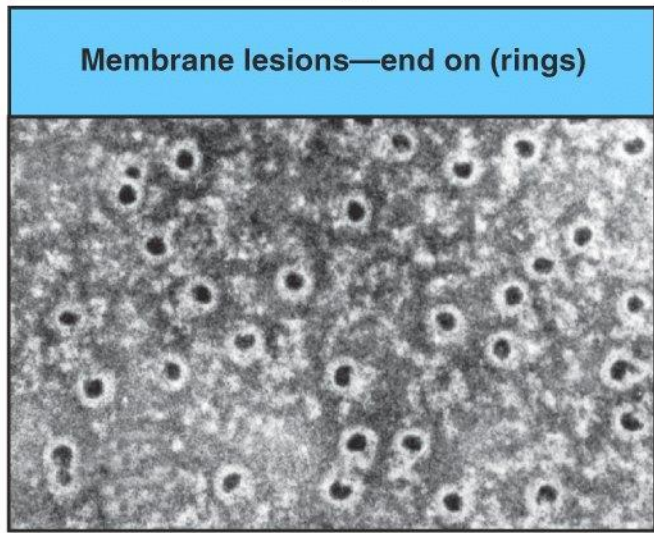
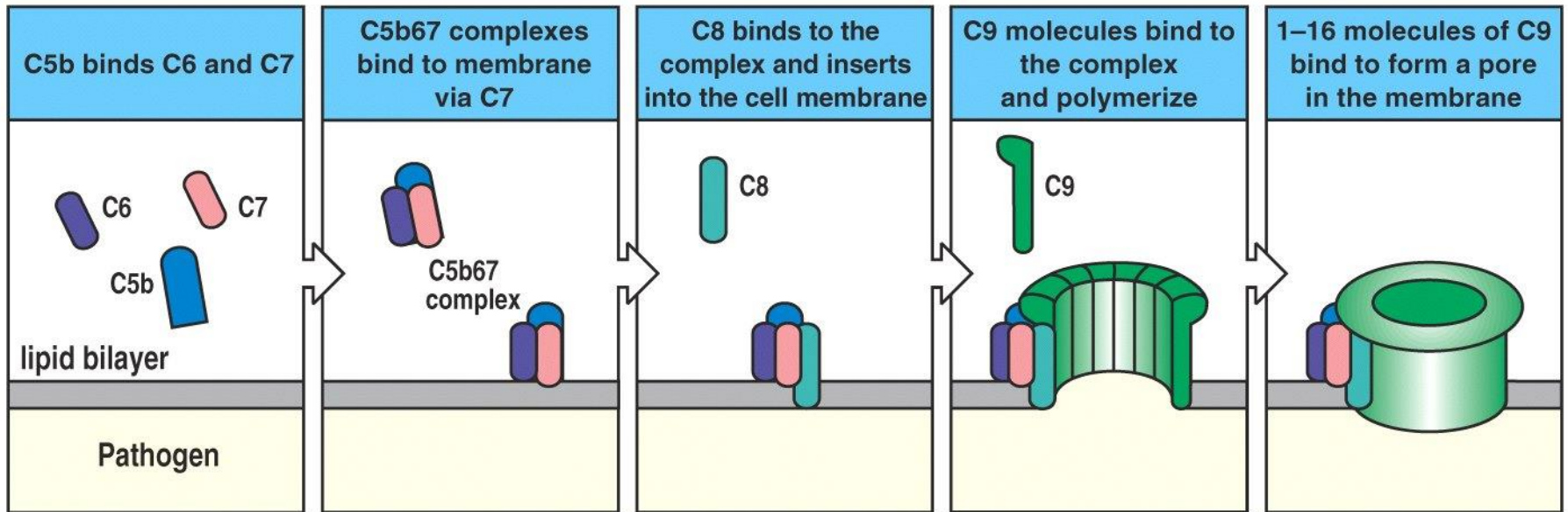

Figure 2-35 Immunobiology, 6/e. (© Garland Science 2005)

EFFECTOR MECHANISMS OF THE INNATE RESPONSE: "NATURAL" KILLING

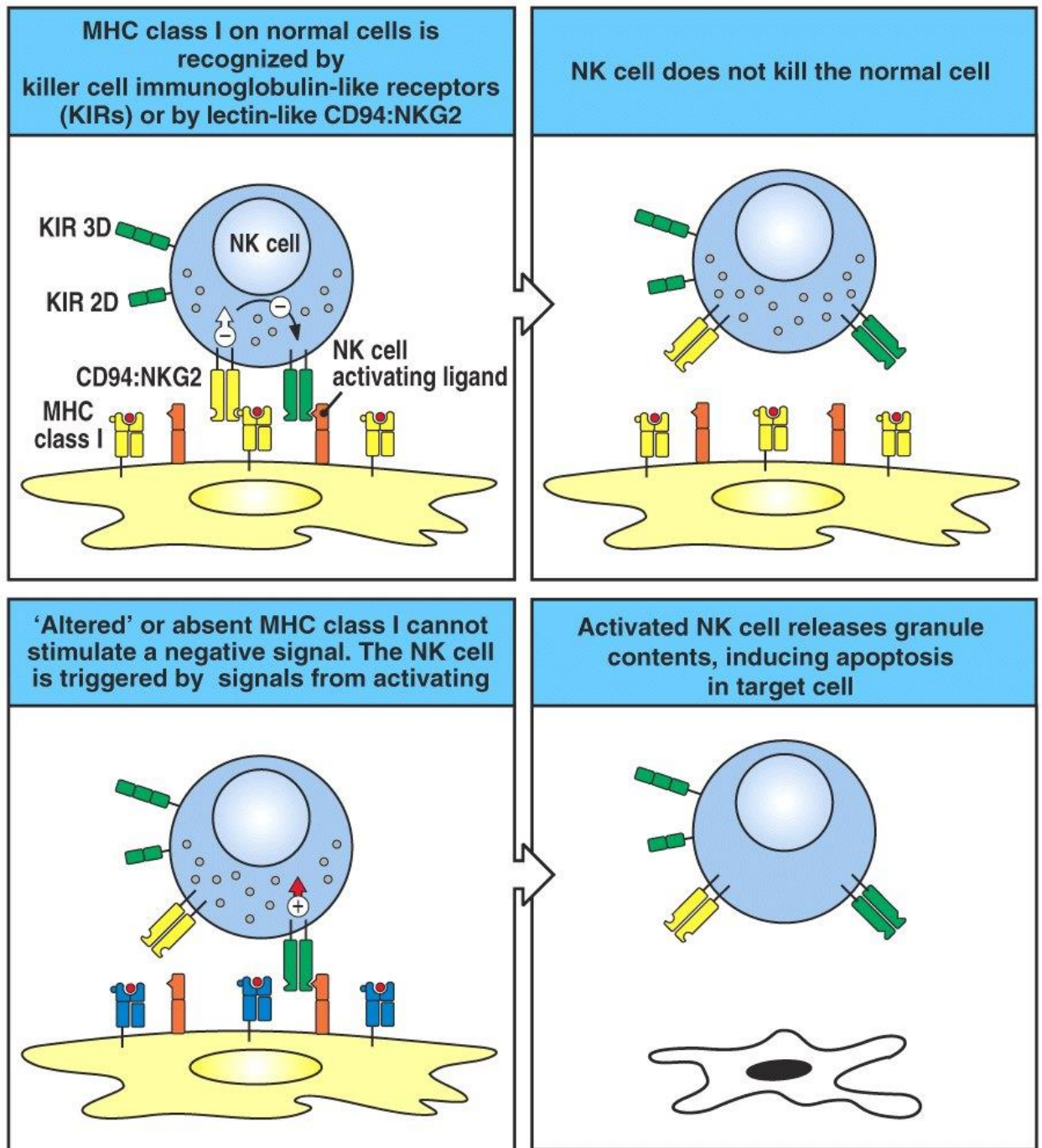
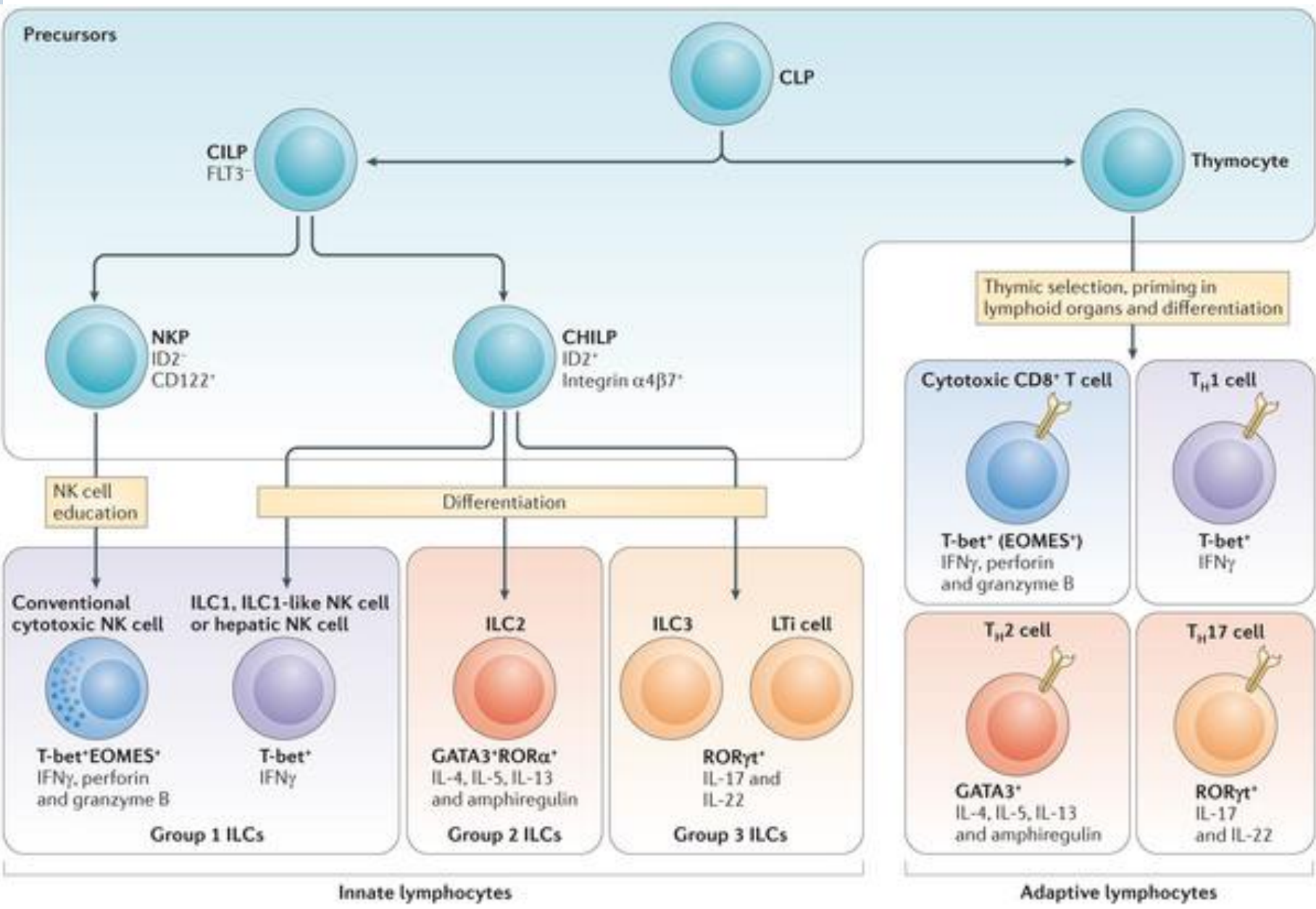

Figure 2-50 Immunobiology, 6/e. (© Garland Science 2005)



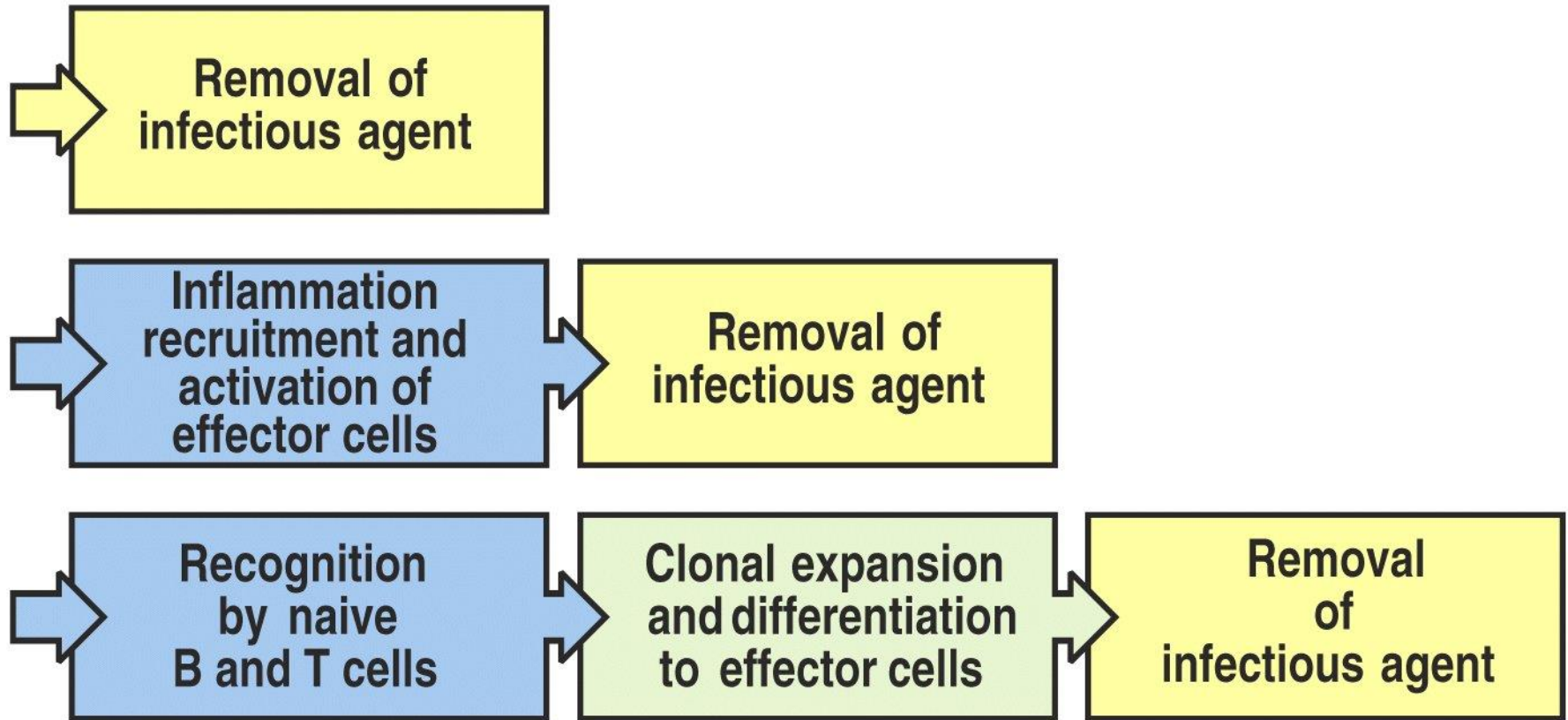
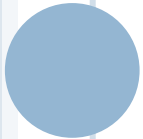

Figure 2-1 part 2 of 2 Immunobiology, 6/e. (© Garland Science 2005)





ADAPTIVE IMMUNITY

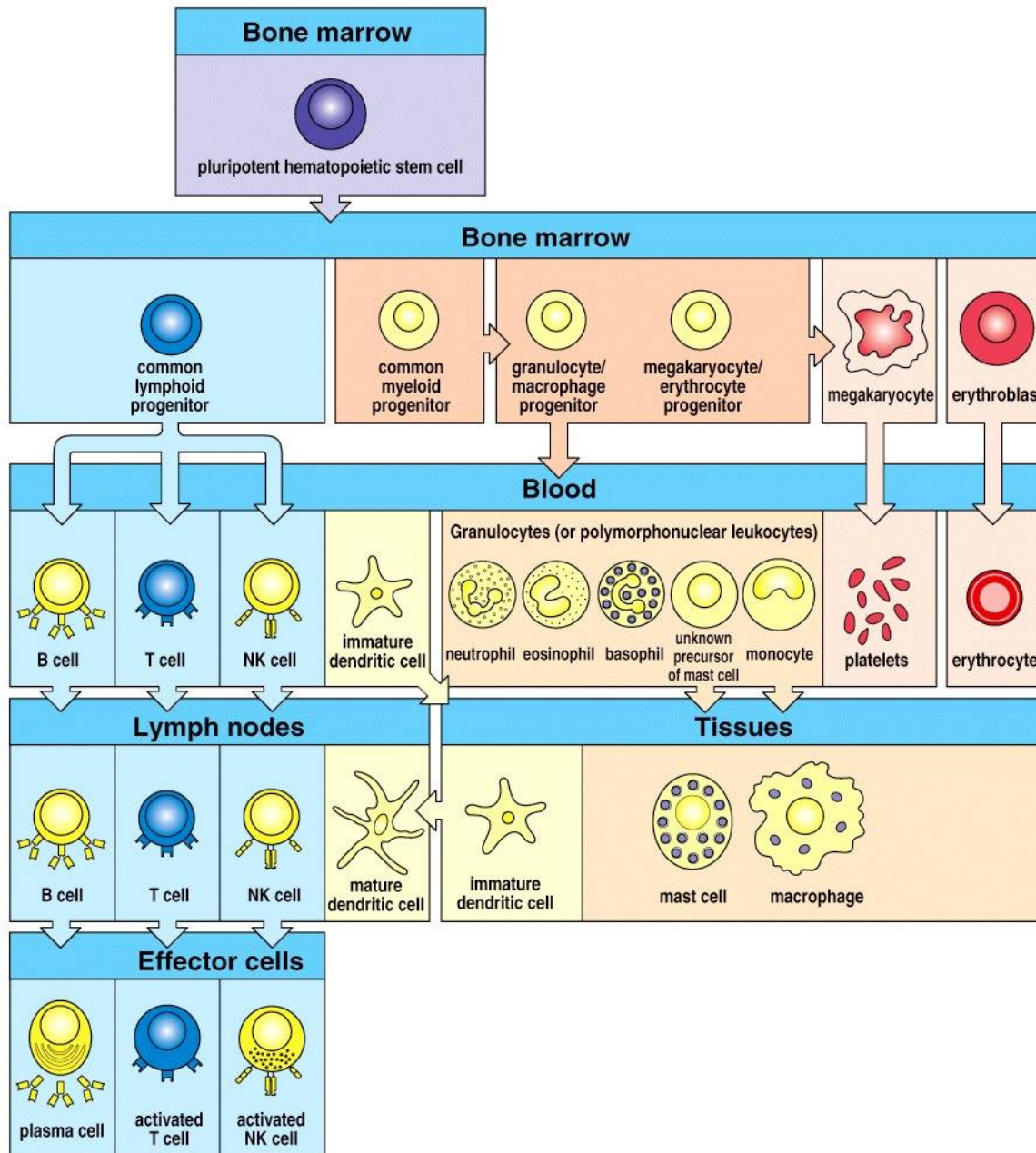

Figure 1-3 Immunobiology, 6/e. (© Garland Science 2005)

B CELL AND T CELLS ARE THE EFFECTORS OF ADAPTIVE IMMUNE RESPONSES

- Three broad arms of adaptive immunity
 - B cells make antibodies, soluble effector molecules (extracellular pathogen removal)
 - CD4 T cells induce other host cell responses, are required for activation and differentiation of CD8 cells and B cells in some situations—the “quarterbacks” of the immune system
 - CD8 cells directly kill infected cells (intracellular pathogen removal)
- All three have memory



Humoral Immunity

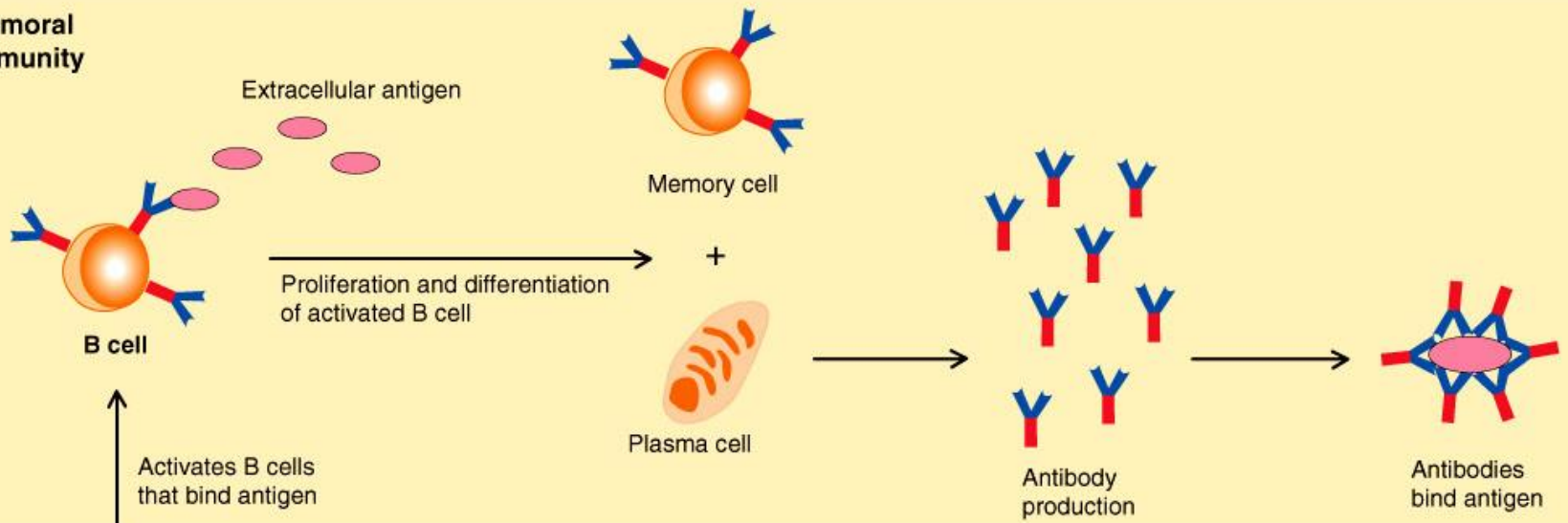

Cellular Immunity

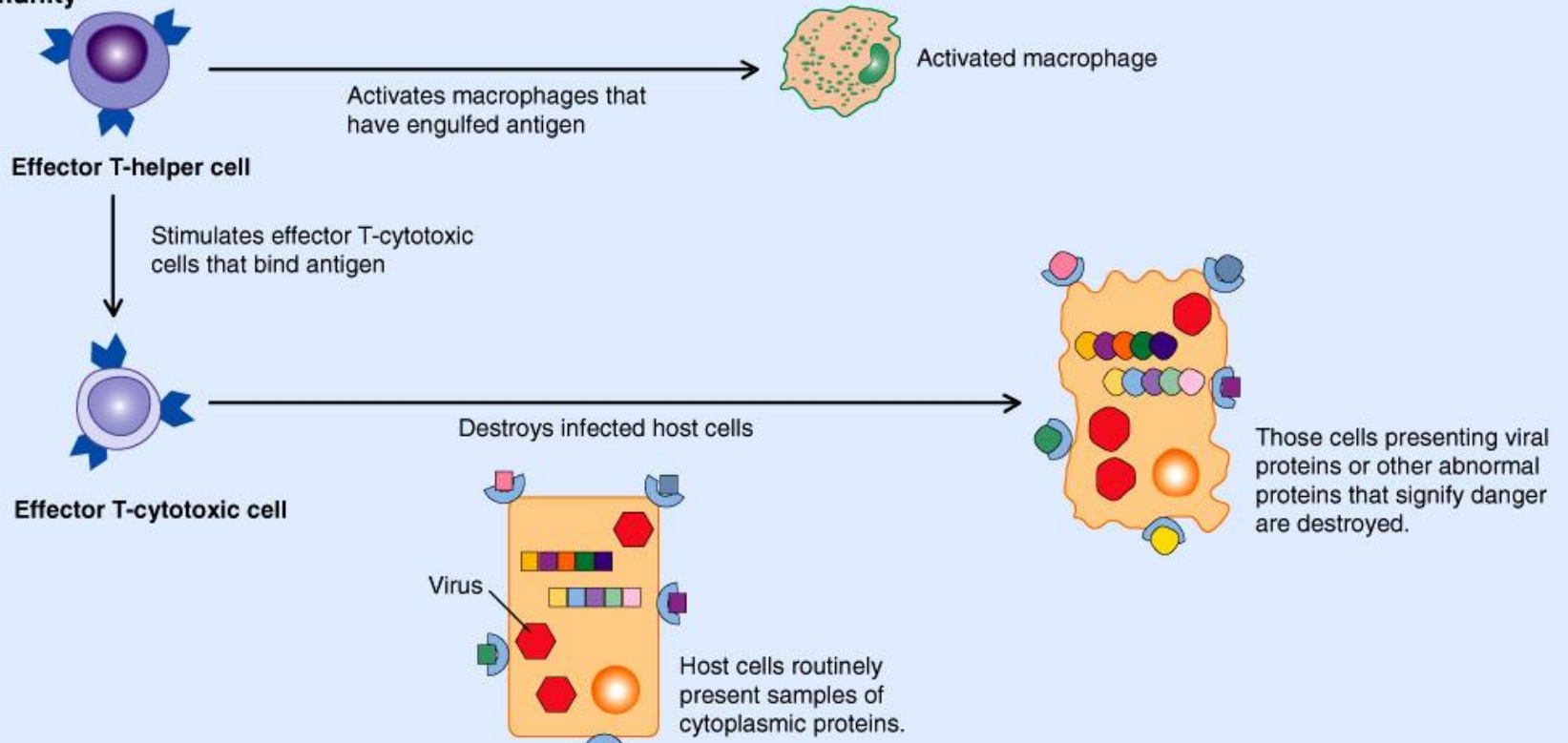

LOCATIONS OF LYMPH NODES

• Lymph nodes are found in groups or chains along the paths of the larger lymphatic vessels throughout the body, including the:

- Cervical region
- Axillary region
- Supratrochlear region
- Inguinal region
- Pelvic cavity
- Abdominal cavity
- Thoracic cavity

Copyright © The McGraw-Hill Companies, Inc. Permission required for reproduction or display.

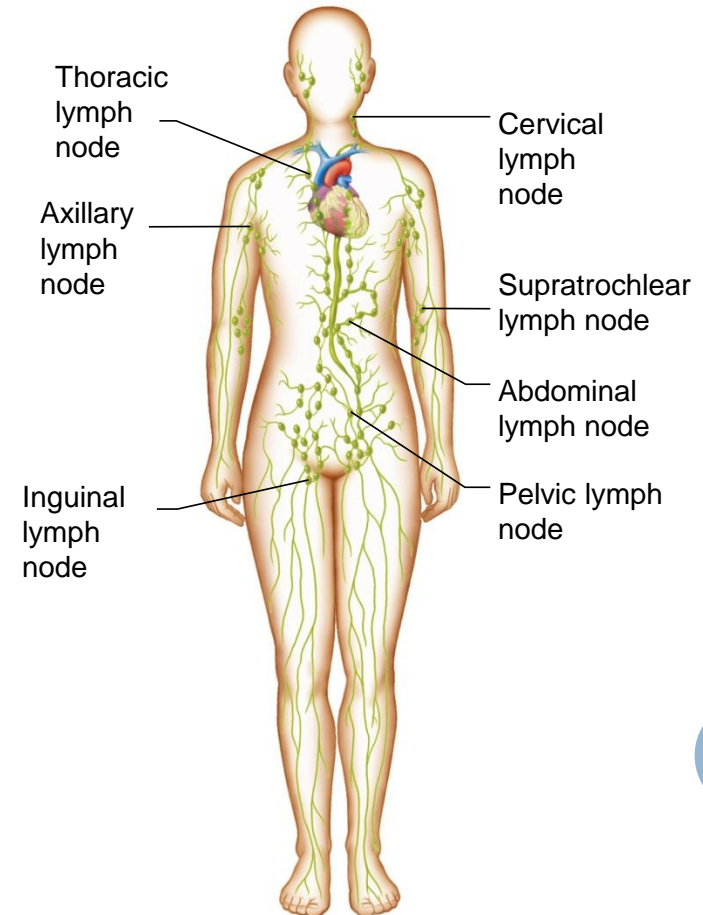

Postulates of the clonal selection hypothesis

Each lymphocyte bears a single type of receptor with a unique specificity

Interaction between a foreign molecule and a lymphocyte receptor capable of binding that molecule with high affinity leads to lymphocyte activation

The differentiated effector cells derived from an activated lymphocyte will bear receptors of identical specificity to those of the parental cell from which that lymphocyte was derived

Lymphocytes bearing receptors specific for ubiquitous self molecules are deleted at an early stage in lymphoid cell development and are therefore absent from the repertoire of mature lymphocytes

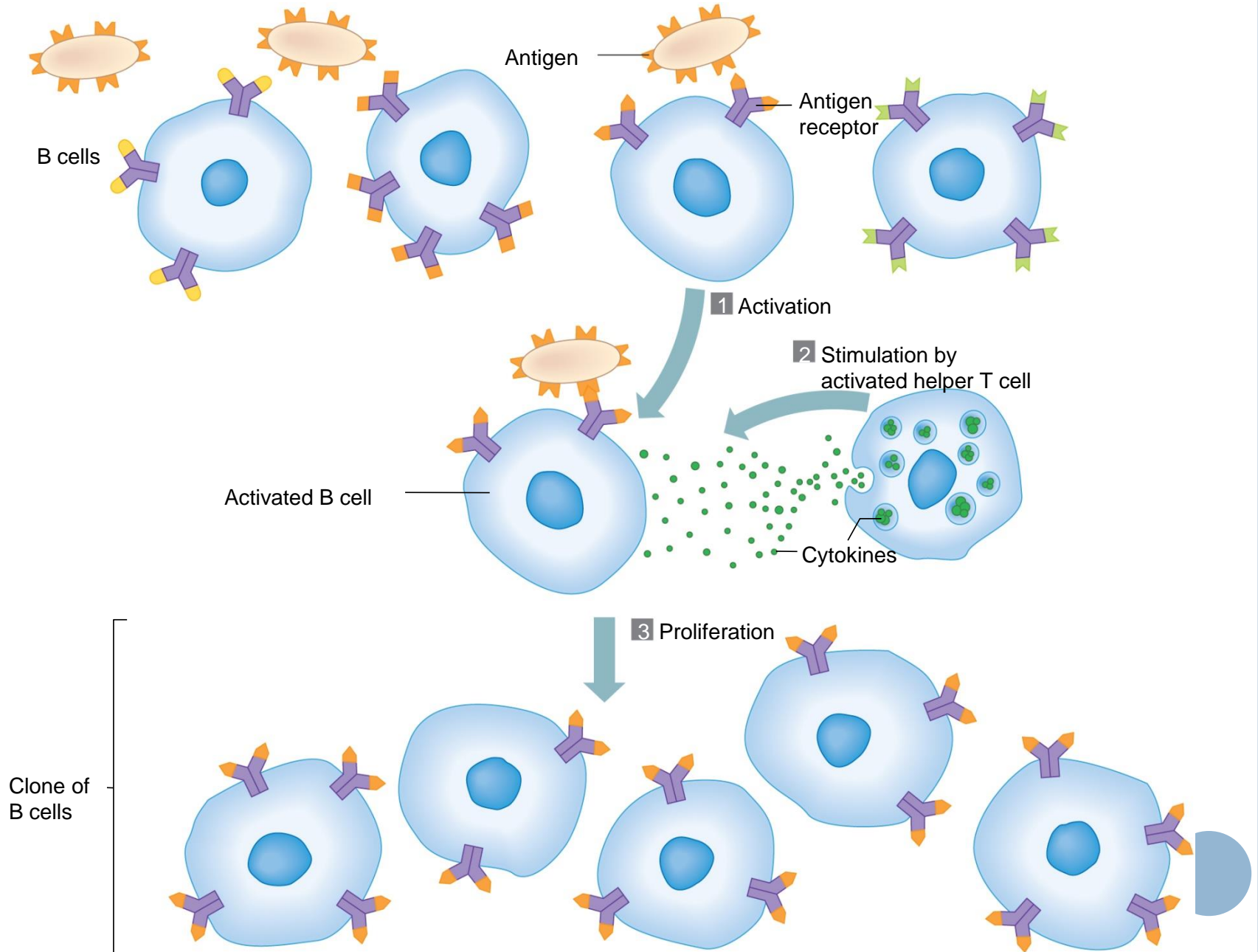

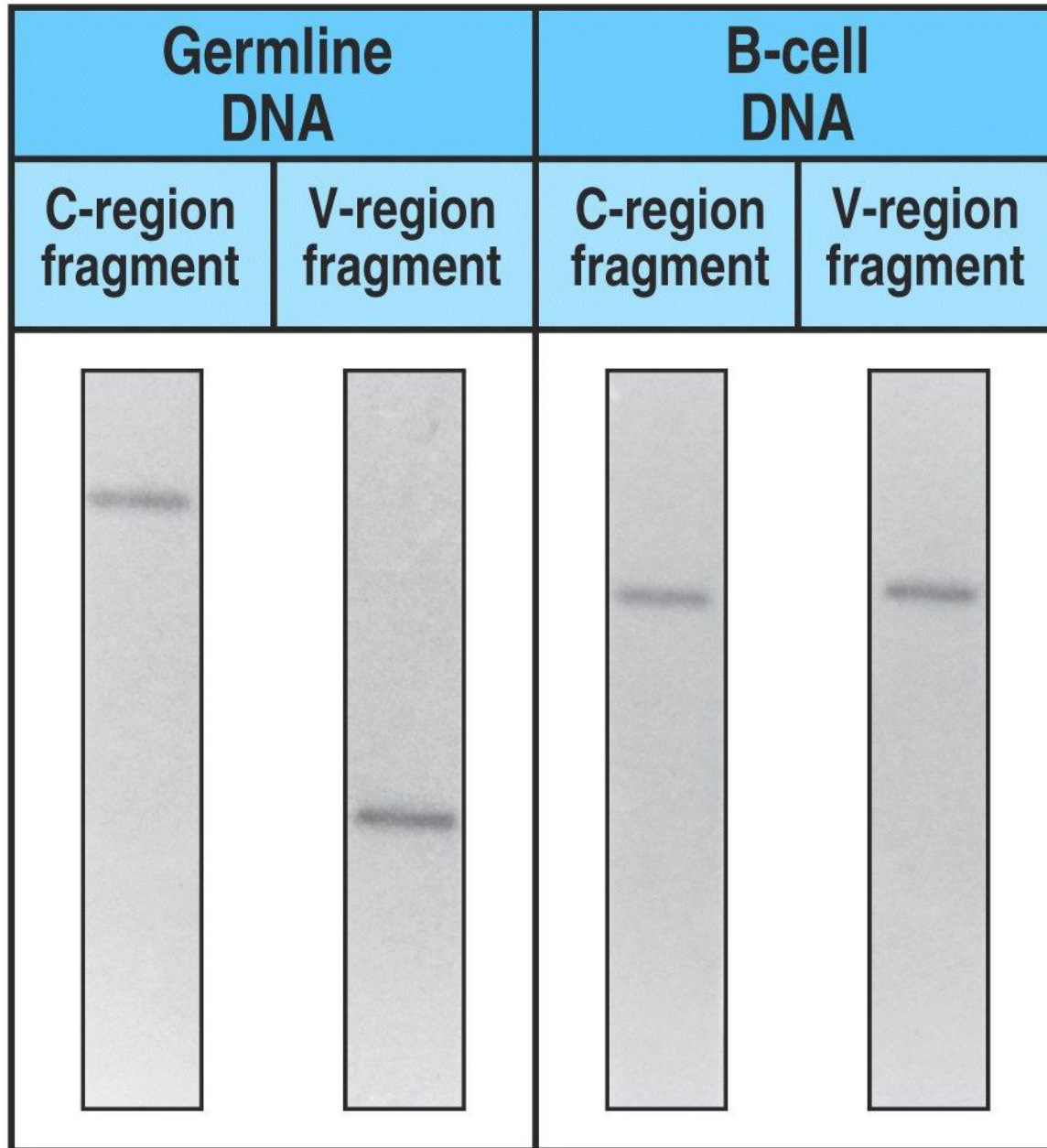

Figure 4-1 Immunobiology, 6/e. (© Garland Science 2005)

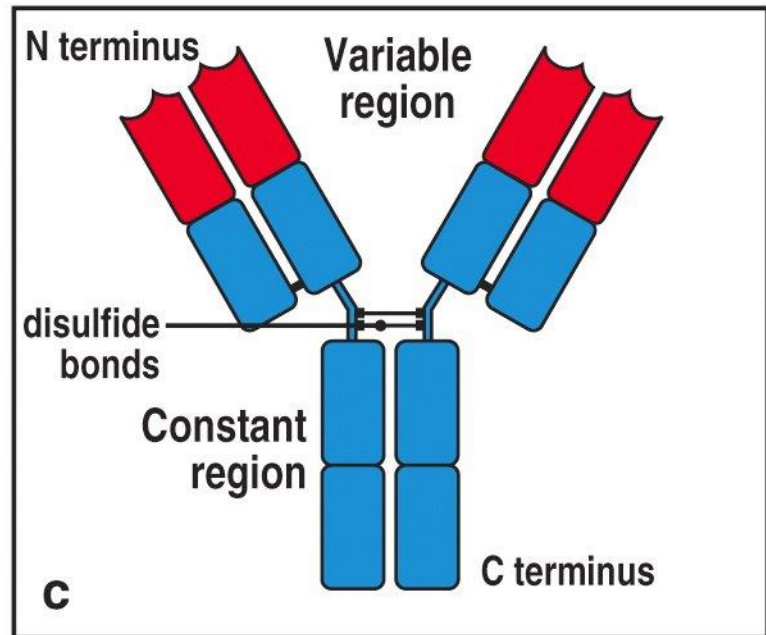
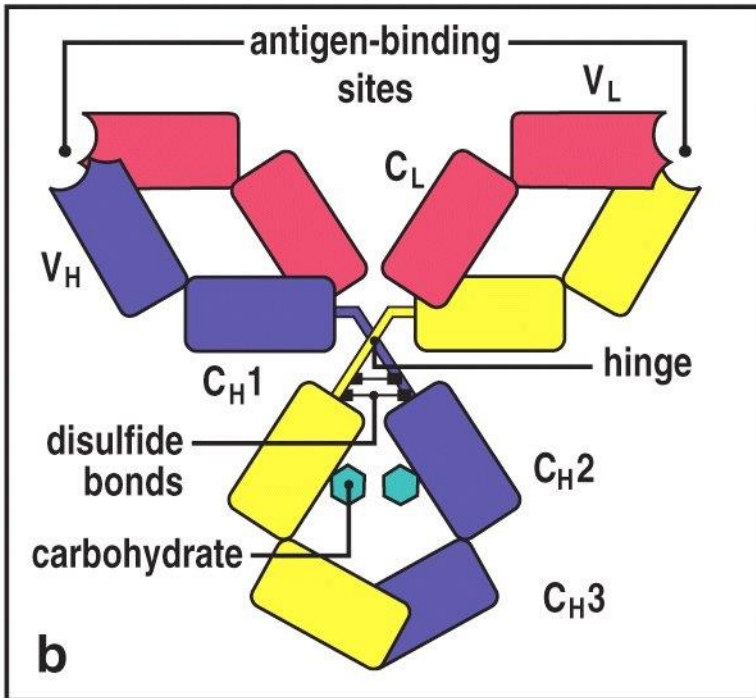

Figure 3-1 Immunobiology, 6/e. (© Garland Science 2005)

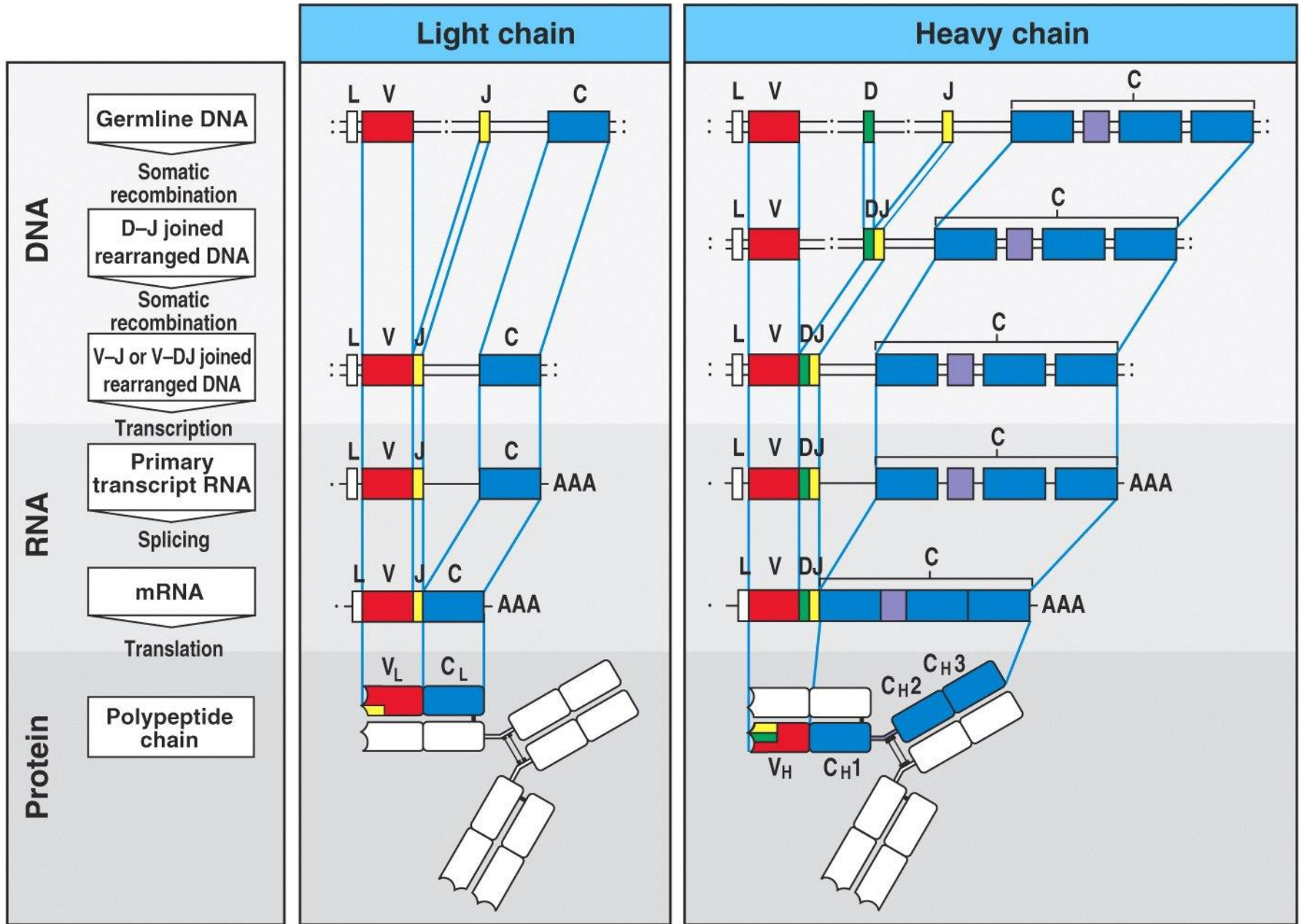

Figure 4-2 Immunobiology, 6/e. (© Garland Science 2005)

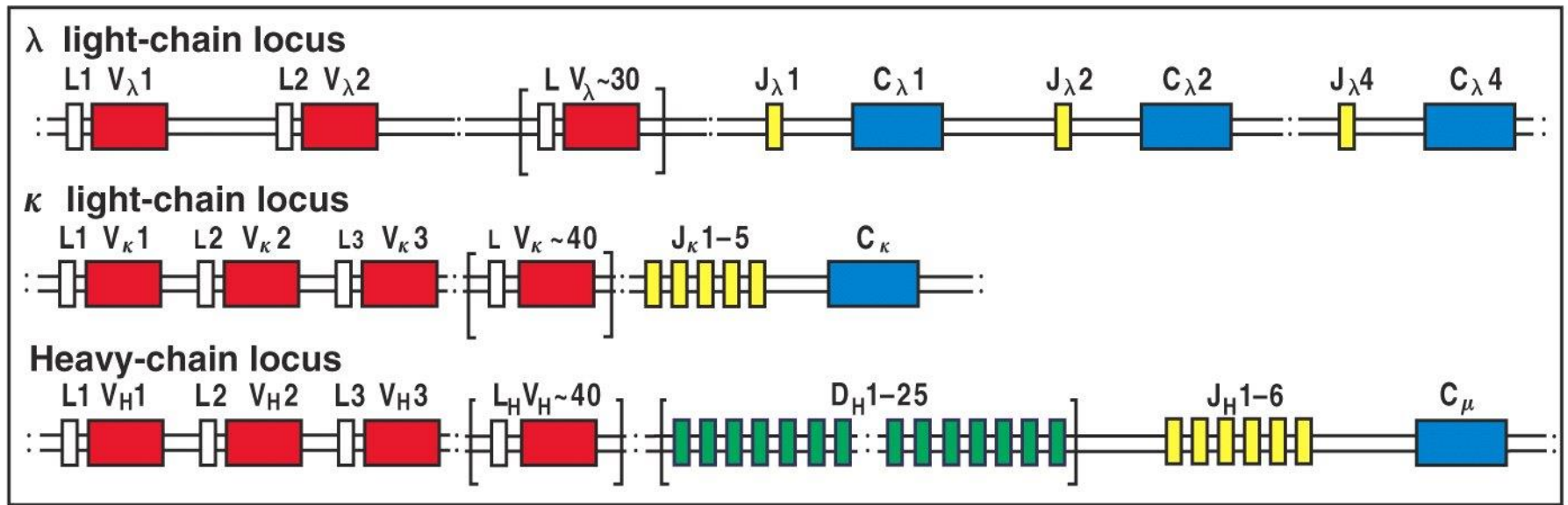

Figure 4-4 Immunobiology, 6/e. (© Garland Science 2005)

Number of functional gene segments in human immunoglobulin loci

Segment	Light chains		Heavy chain
	κ	λ	H
Variable (V)	40	30	40
Diversity (D)	0	0	25
Joining (J)	5	4	6

Figure 4-3 Immunobiology, 6/e. (© Garland Science 2005)

Element	Immunoglobulin		$\alpha:\beta$ T-cell receptors	
	H	$\kappa+\lambda$	β	α
Variable segments (V)	40	70	52	~70
Diversity segments (D)	25	0	2	0
D segments read in three frames	rarely	—	often	—
Joining segments (J)	6	5(κ) 4(λ)	13	61
Joints with N- and P-nucleotides	2	50% of joints	2	1
Number of V gene pairs	1.9×10^6		5.8×10^6	
Junctional diversity	$\sim 3 \times 10^7$		$\sim 2 \times 10^{11}$	
Total diversity	$\sim 5 \times 10^{13}$		$\sim 10^{18}$	

Figure 4-13 Immunobiology, 6/e. (© Garland Science 2005)

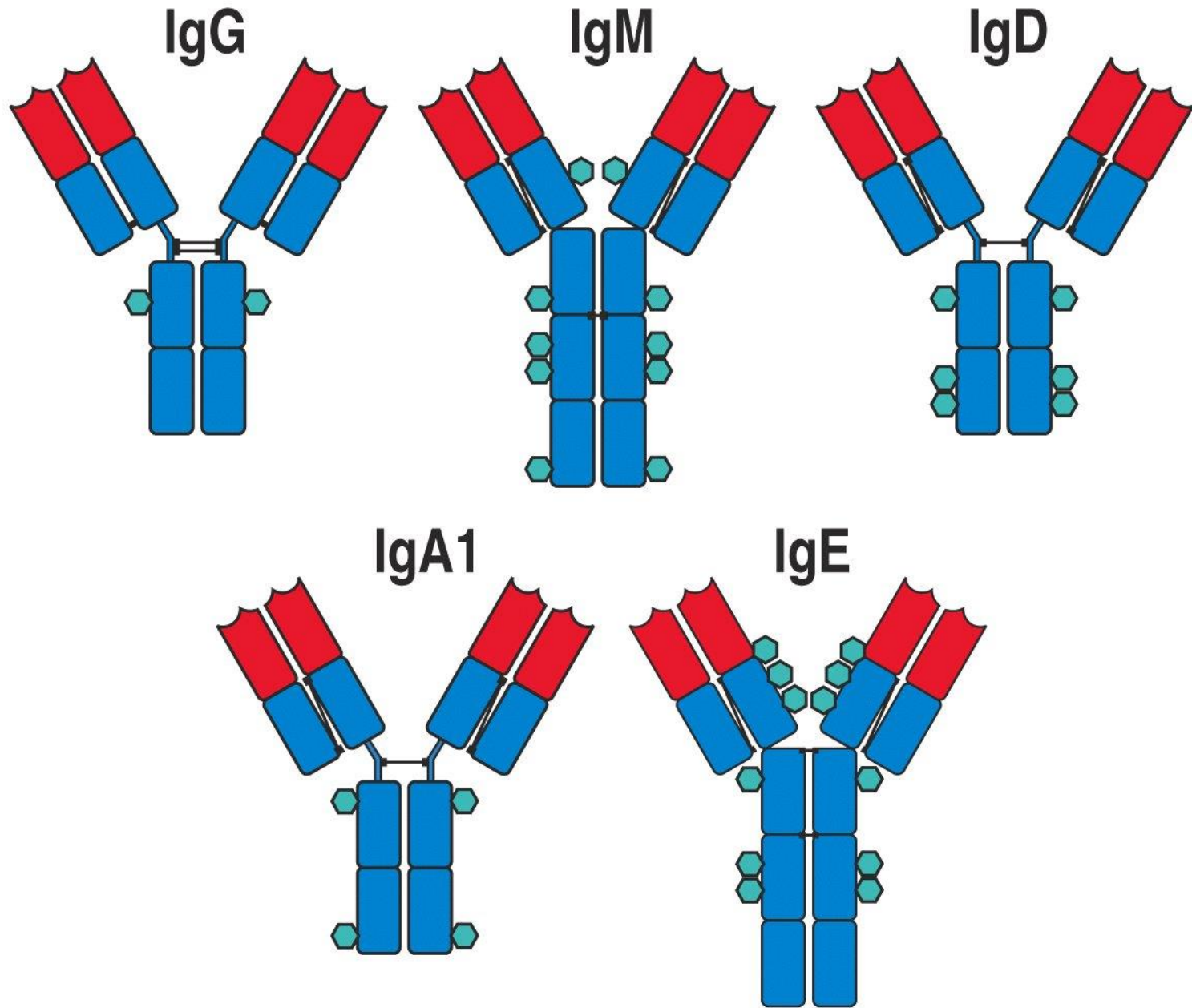

Figure 4-18 Immunobiology, 6/e. (© Garland Science 2005)

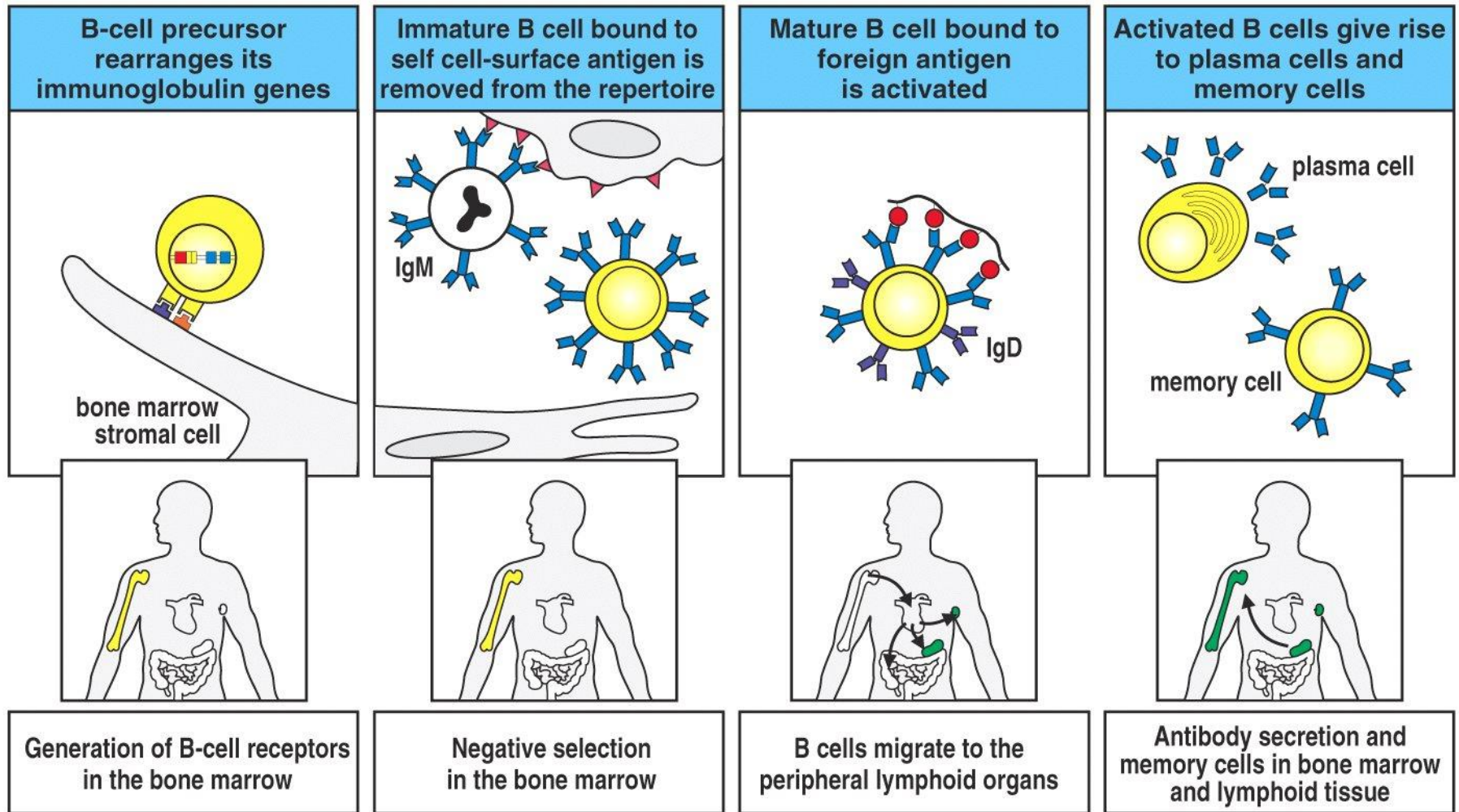

Figure 7-1 Immunobiology, 6/e. (© Garland Science 2005)

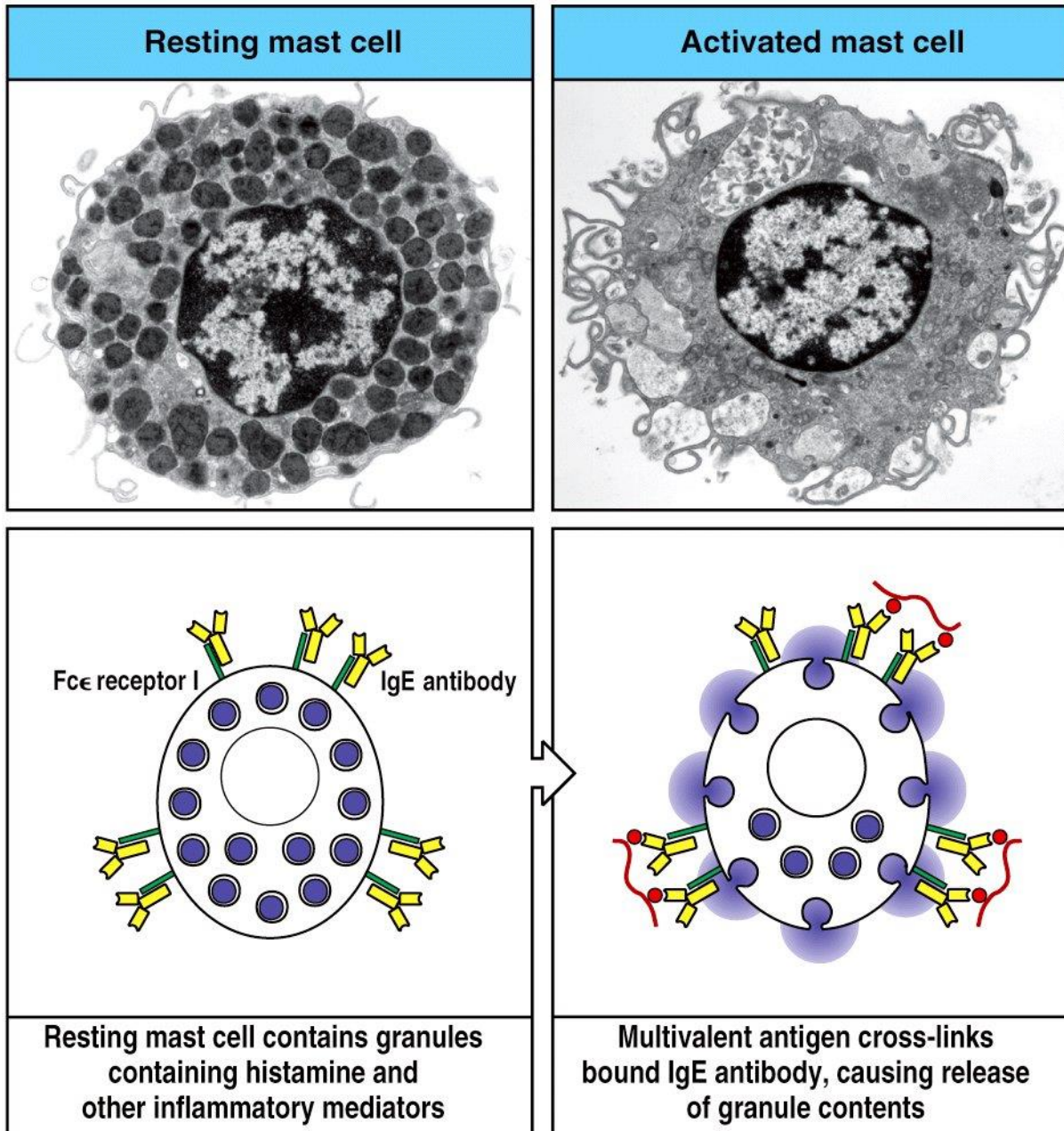

Figure 9-35 Immunobiology, 6/e. (© Garland Science 2005)

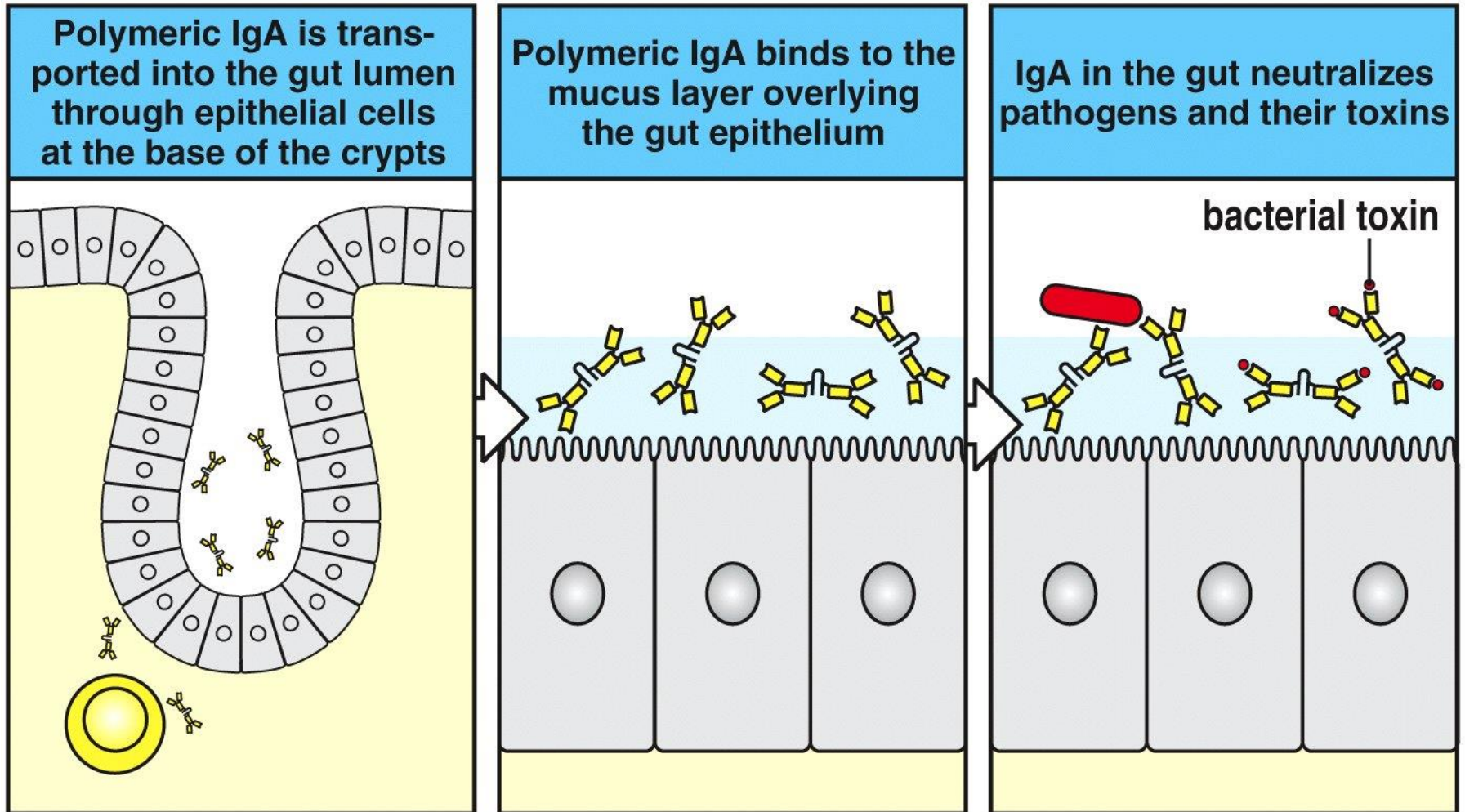

Figure 10-24 Immunobiology, 6/e. (© Garland Science 2005)

B CELL MEMORY QUALITY IS ENHANCED BY AFFINITY MATURATION

- Antigen-specific B cells can mature in a cellular structure called the “germinal center”, where they are given stimulation by CD4 T cells and antigen, leading to new mutations in the CDR regions of the genomic DNA encoding the antibody
- Cells that increase affinity for antigen survive and continue rearrangements
- Cells that lose affinity either rearrange to higher affinity or die
- During this period, antibody is not secreted

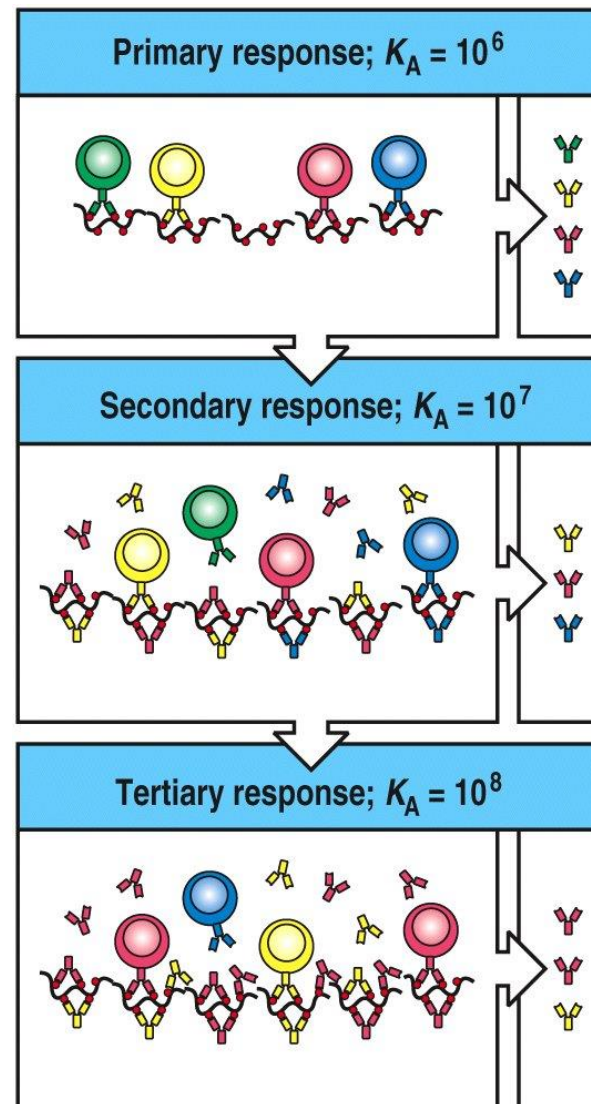

Figure 10-32 Immunobiology, 6/e. (© Garland Science 2005)

TABLE 16.7 | Characteristics of Major Immunoglobulins

Type	Occurrence	Major Function
IgG	Plasma and tissue fluid	Defends against bacteria, viruses, and toxins; activates complement
IgA	Exocrine gland secretions	Defends against bacteria and viruses
IgM	Plasma	Reacts with antigens on some red blood cell membranes following mismatched blood transfusions; activates complement
IgD	Surface of most B lymphocytes	B cell activation
IgE	Exocrine gland secretions	Promotes inflammation and allergic reactions

TABLE 16.8 | Actions of Antibodies

General Action	Type of Effect	Description
Direct Attack		
	Agglutination	Antigens clump
	Precipitation	Antigens become insoluble
	Neutralization	Antigens lose toxic properties
Activation of Complement (Antibodies combined with antigens)		
	Opsonization	Alters antigen cell membranes so cells are more susceptible to phagocytosis
	Chemotaxis	Attracts macrophages and neutrophils into the region
	Agglutination	Clumping of antigen-bearing cells
	Lysis	Allows rapid movement of water and ions into the foreign cell causing osmotic rupture of the foreign cell
	Neutralization	Altering the molecular structure of viruses, making them harmless
Localized Changes		
	Inflammation	Helps prevent the spread of antigens

T-CELL MEDIATED RECOGNITION

- The T-cell receptor is very similar in structure to an antibody, with a highly variable antigen-binding site formed by V(D)J recombination
- However, it is solely membrane bound and is restricted in the types of antigens it recognizes

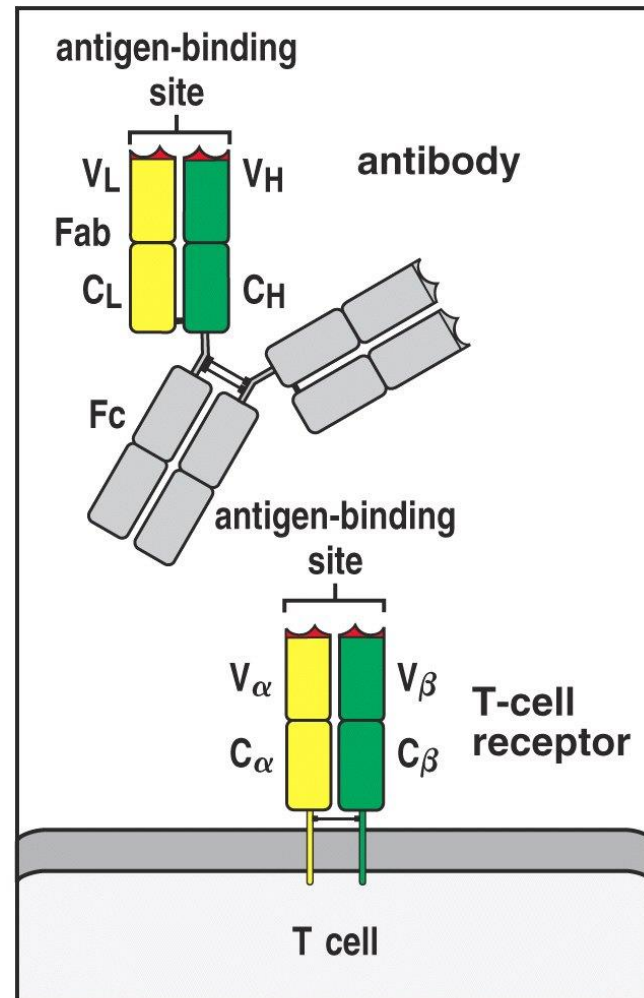

Figure 3-11 Immunobiology, 6/e. (© Garland Science 2005)

T CELLS ARE ACTIVATED BY SPECIFIC ANTIGEN AND CO-STIMULATION (NON-SPECIFIC, DOWNSTREAM OF INNATE ACTIVATION)

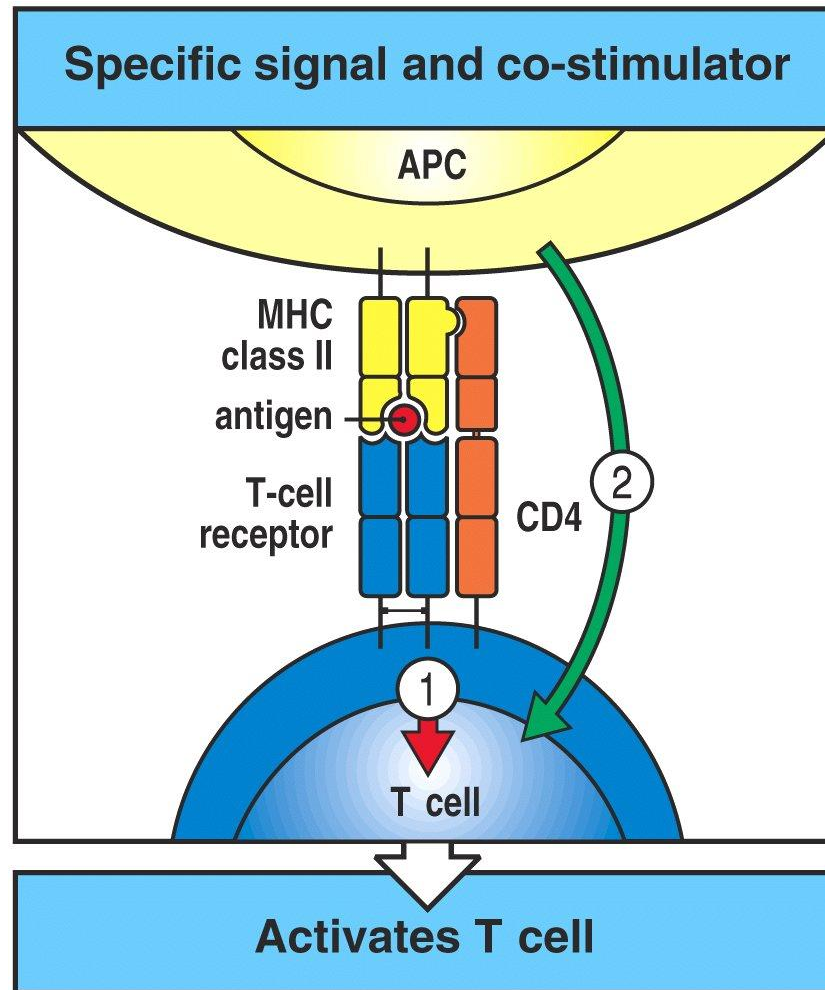

Figure 8-10 Immunobiology, 6/e. (© Garland Science 2005)

MHC MOLECULES ARE COMPARTMENTS FOR HOLDING PEPTIDE ANTIGEN

- MHC molecules are cell surface receptors that contain a peptide-binding cleft
- Small protein pieces (8-20 aa long, depending on the MHC molecule)
- First identified as transplant compatibility antigens (more on this later)

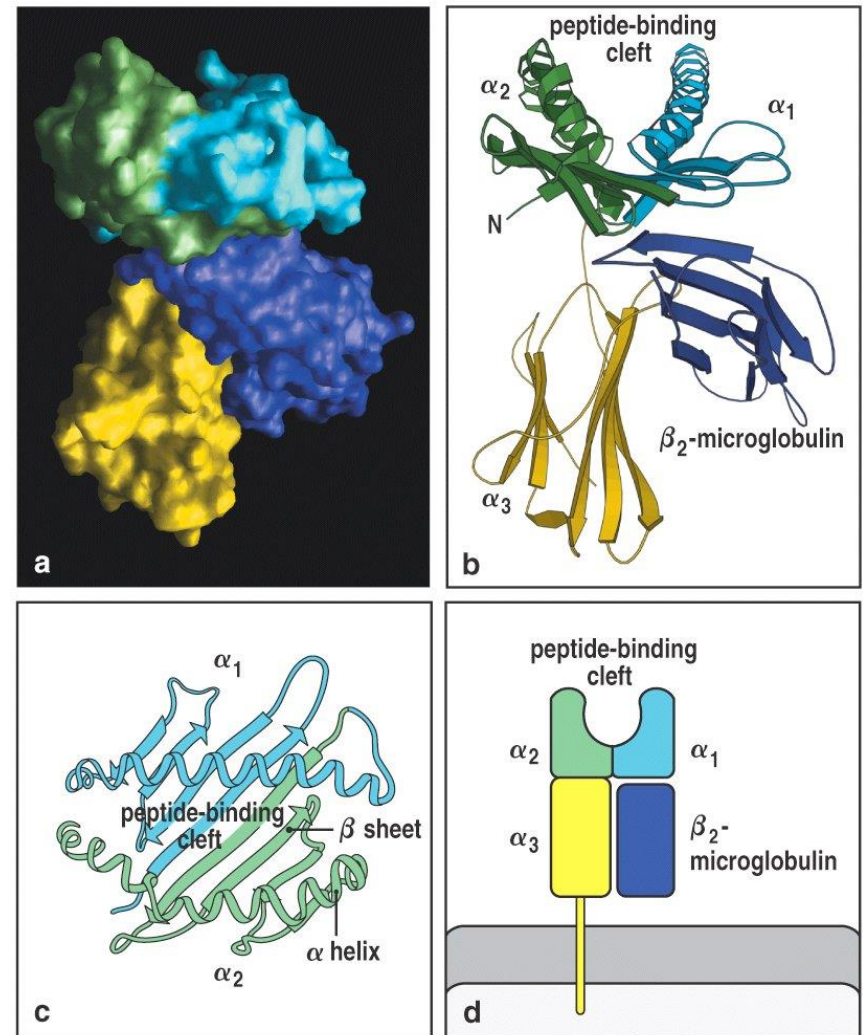

Figure 3-20 Immunobiology, 6/e. (© Garland Science 2005)

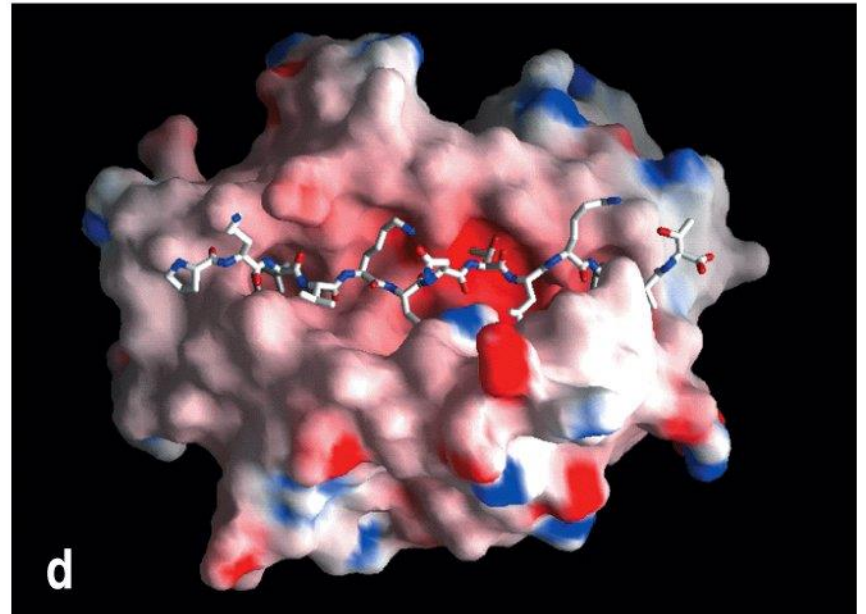
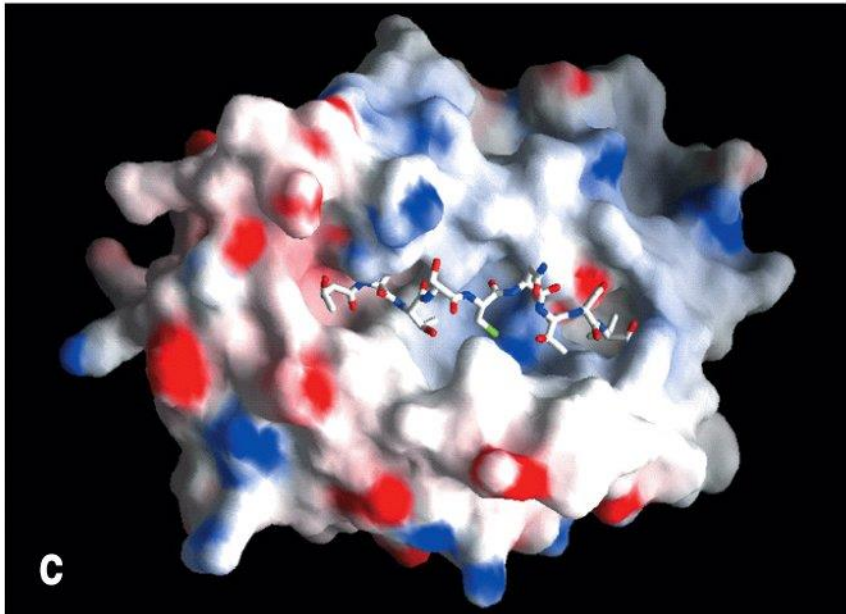
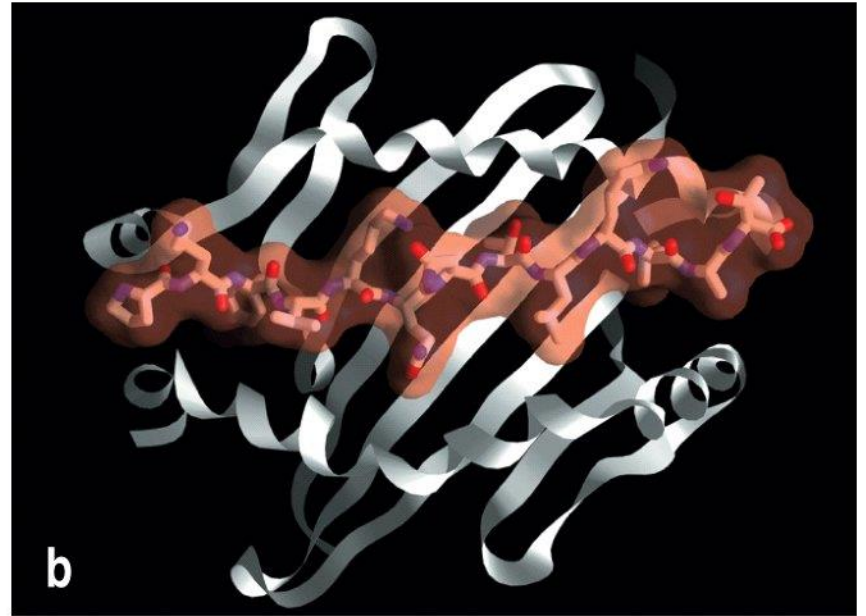
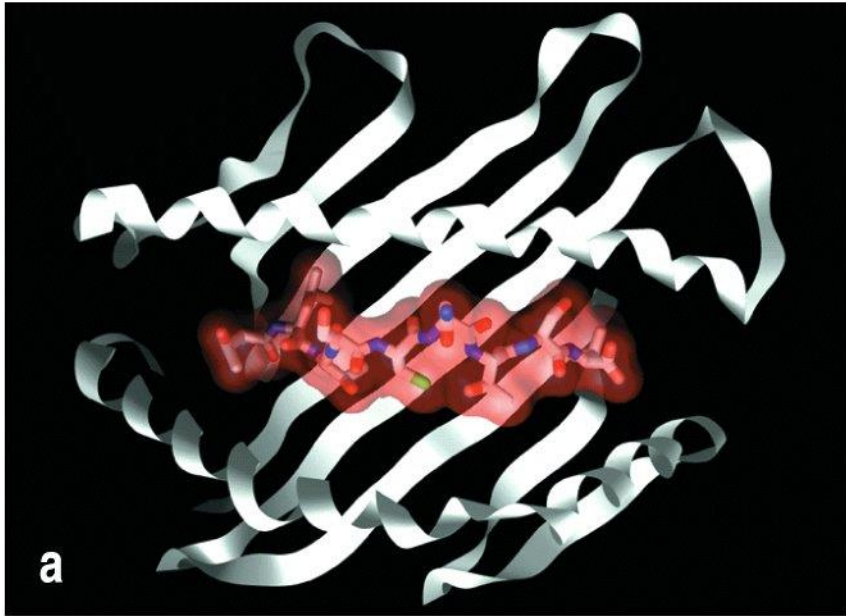

Figure 3-22 Immunobiology, 6/e. (© Garland Science 2005)

T CELL LINEAGES DETERMINE MHC RESTRICTION

- CD4 and CD8 molecules both expressed during development—whether a T cell becomes CD4 or CD8 positive in maturity is dependent on the “restriction” of its TCR—whether it preferentially interacts with Major Histocompatibility Complex I (MHCI) or MHCII molecules

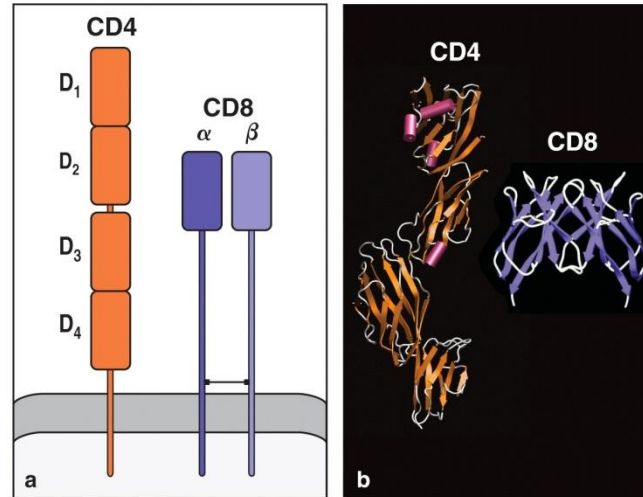

Figure 3-15 Immunobiology, 6/e. (© Garland Science 2005)

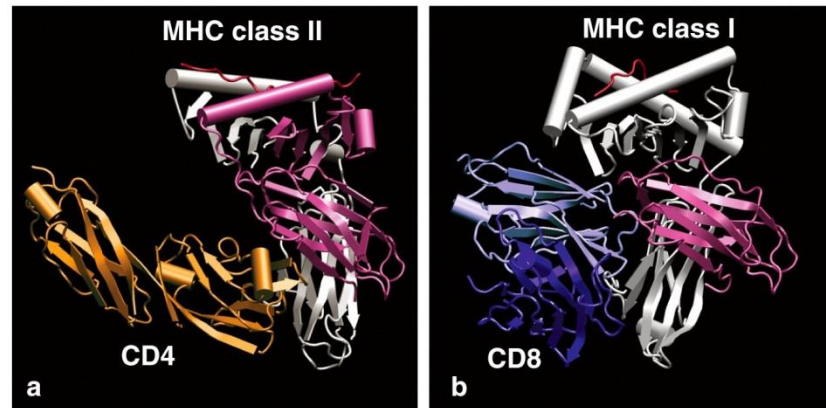

Figure 3-16 Immunobiology, 6/e. (© Garland Science 2005)



THYMUS SELECTION RESTRICTS MHC RECOGNITION AND REMOVES AUTOREACTIVE CELLS

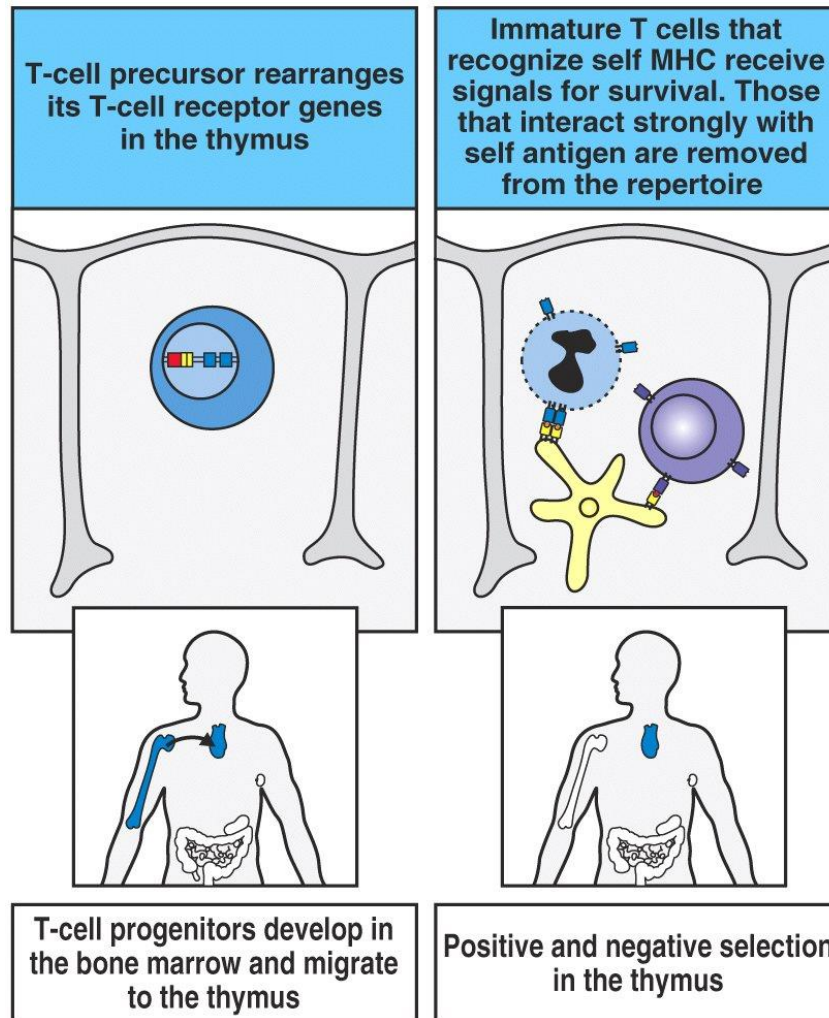

Figure 7-2 part 1 of 2 Immunobiology, 6/e. (© Garland Science 2005)



DENDRITIC CELLS ARE THE MOST EFFICIENT ANTIGEN-PRESENTING CELLS AND ARE GENERALLY REQUIRED FOR THE INITIATION OF ADAPTIVE IMMUNITY

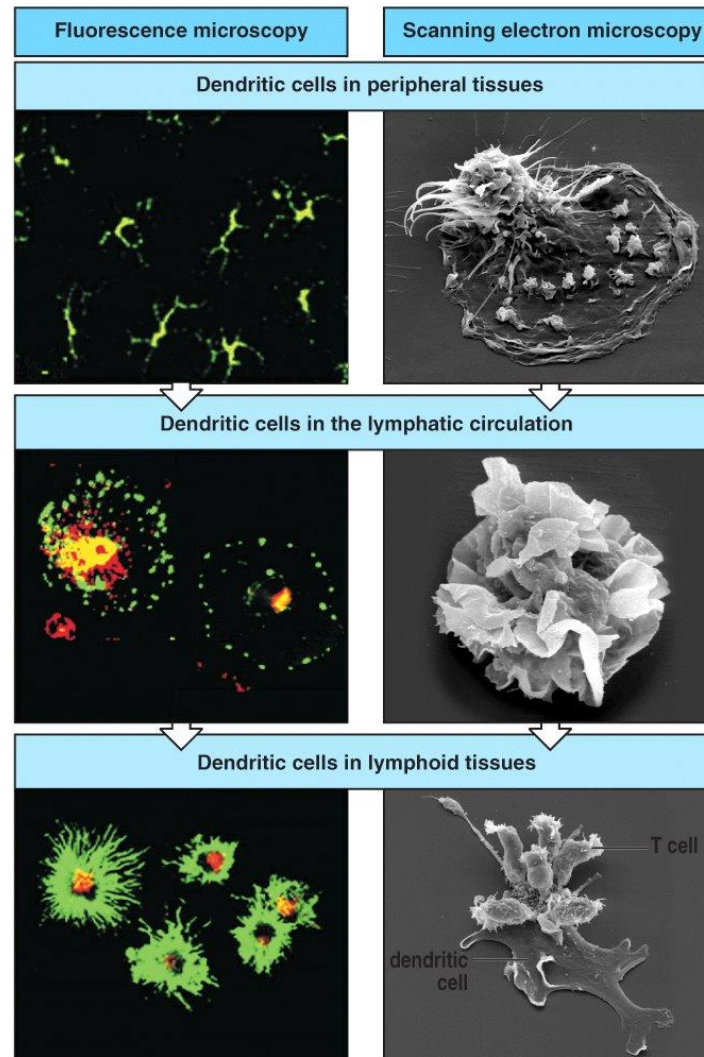

Figure 8-2 Immunobiology, 6/e. (© Garland Science 2005)



T CELLS ARE ACTIVATED BY SPECIFIC ANTIGEN AND CO-STIMULATION (NON-SPECIFIC, DOWNSTREAM OF INNATE ACTIVATION)

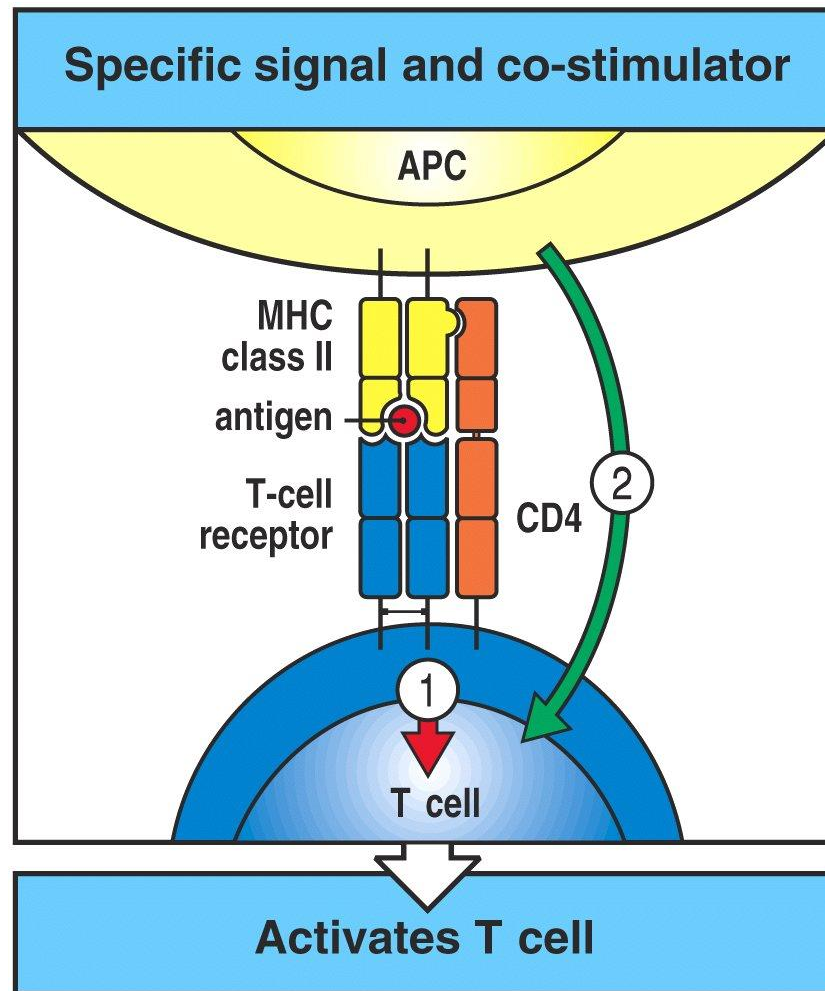

Figure 8-10 Immunobiology, 6/e. (© Garland Science 2005)

	Dendritic cells	Macrophages	B cells
			
Antigen uptake	+++ Macropinocytosis and phagocytosis by tissue dendritic cells Viral infection	Phagocytosis +++	Antigen-specific receptor (Ig) ++++
MHC expression	Low on tissue dendritic cells High on dendritic cells in lymphoid tissues	Inducible by bacteria and cytokines - to +++	Constitutive Increases on activation +++ to ++++
Co-stimulator delivery	Constitutive by mature, nonphagocytic lymphoid dendritic cells ++++	Inducible - to +++	Inducible - to +++
Antigen presented	Peptides Viral antigens Allergens	Particulate antigens Intracellular and extracellular pathogens	Soluble antigens Toxins Viruses
Location	Ubiquitous throughout the body	Lymphoid tissue Connective tissue Body cavities	Lymphoid tissue Peripheral blood

Figure 8-18 Immunobiology, 6/e. (© Garland Science 2005)

STRUCTURE OF A LYMPH NODE

Copyright © The McGraw-Hill Companies, Inc. Permission required for reproduction or display.

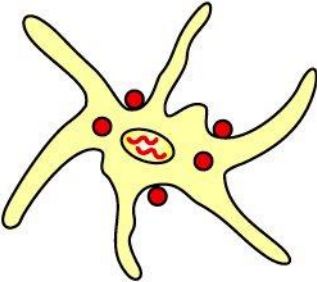
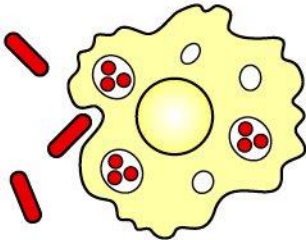
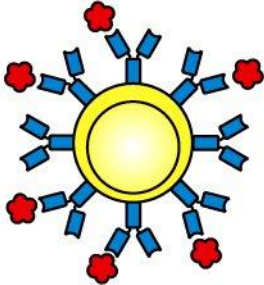
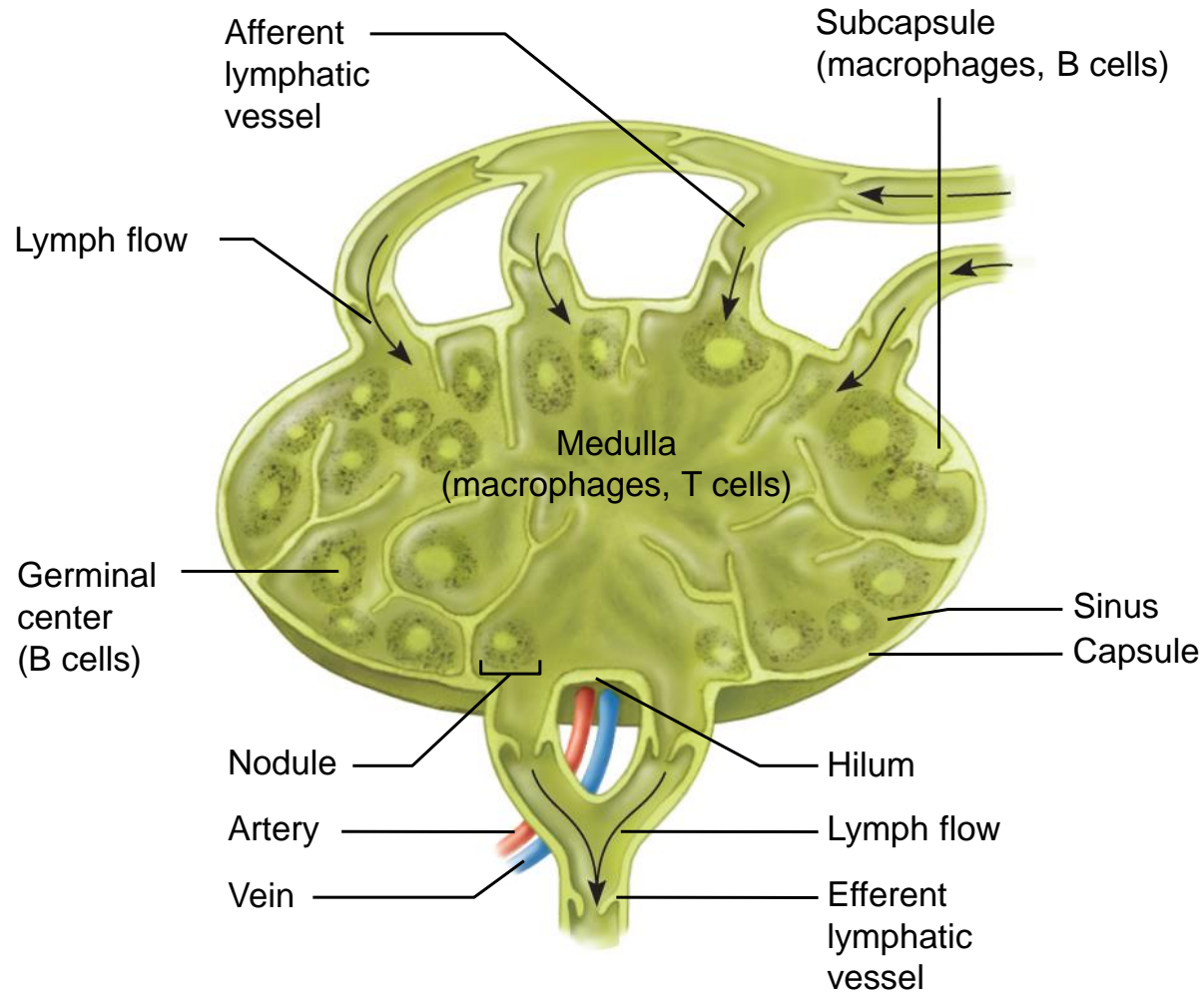

(a)



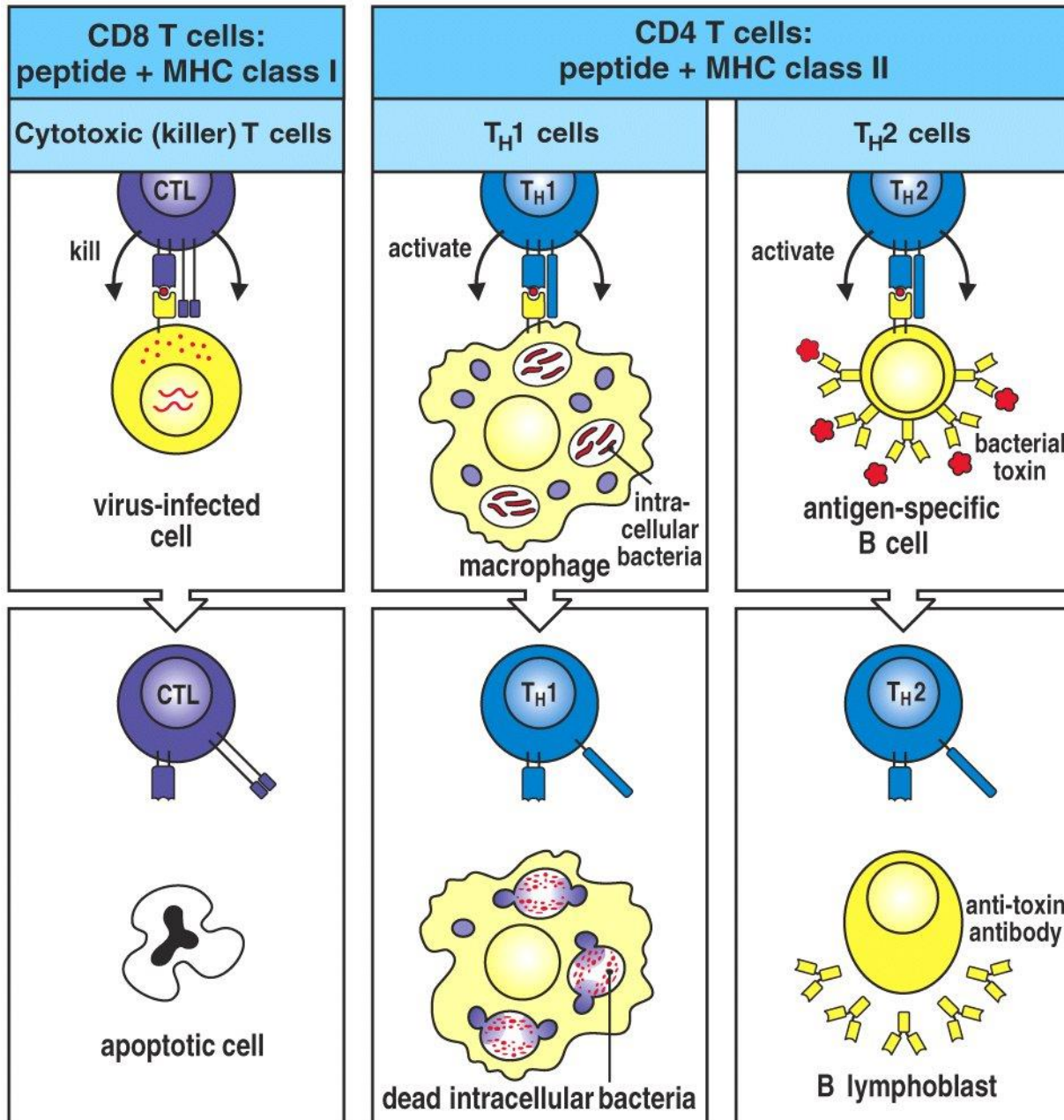
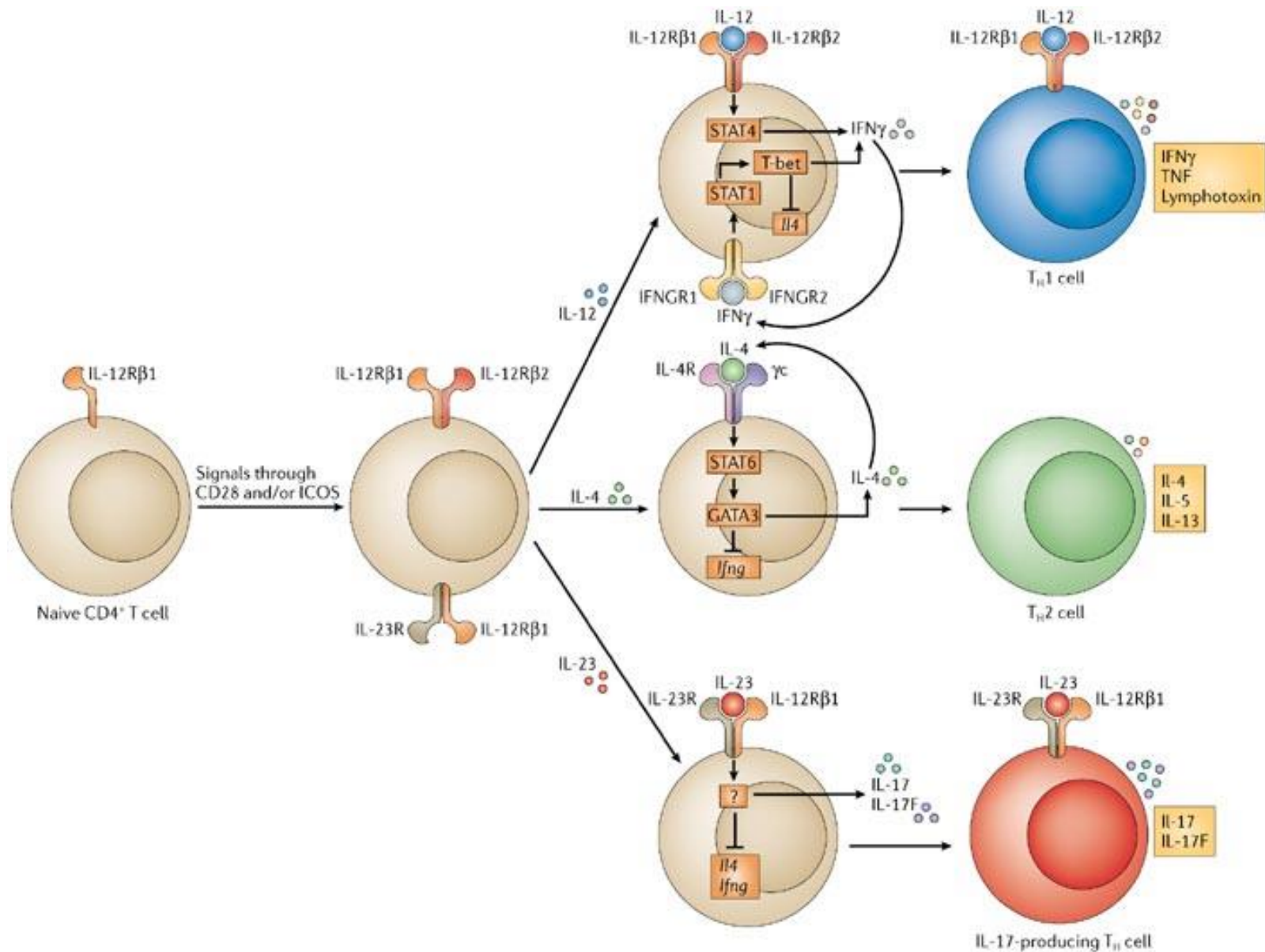

Figure 8-27 Immunobiology, 6/e. (© Garland Science 2005)

CD4 CELLS CAN DIFFERENTIATE INTO MULTIPLE TYPES OF "HELPERS"



ACTIVATED CELLS ARE NOW LICENSED TO SEEK OUT
TARGETS AND KILL THEM
FOR CD8 T CELLS, NUMBERS ARE CRITICAL

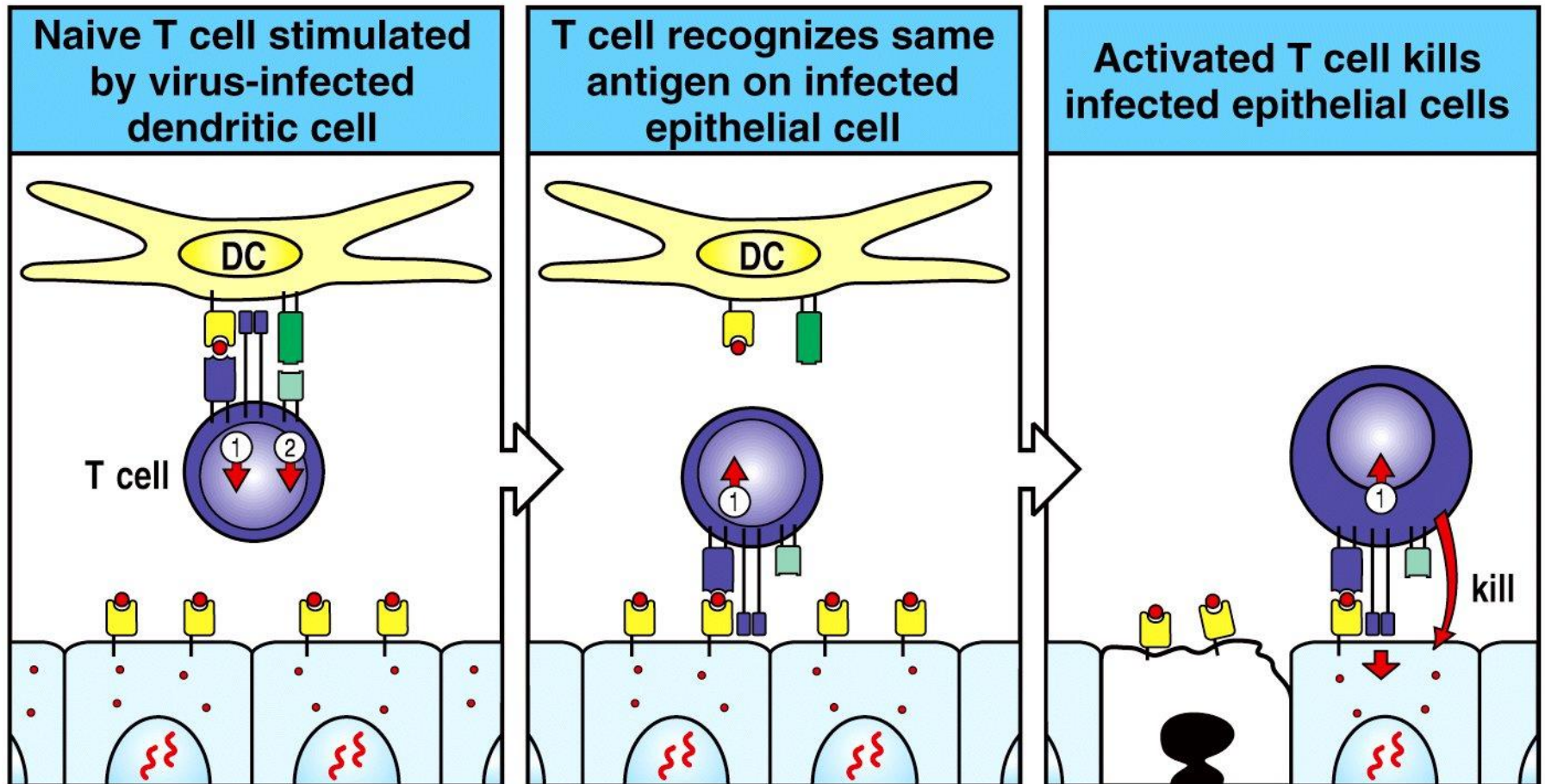

Figure 8-13 part 1 of 2 Immunobiology, 6/e. (© Garland Science 2005)

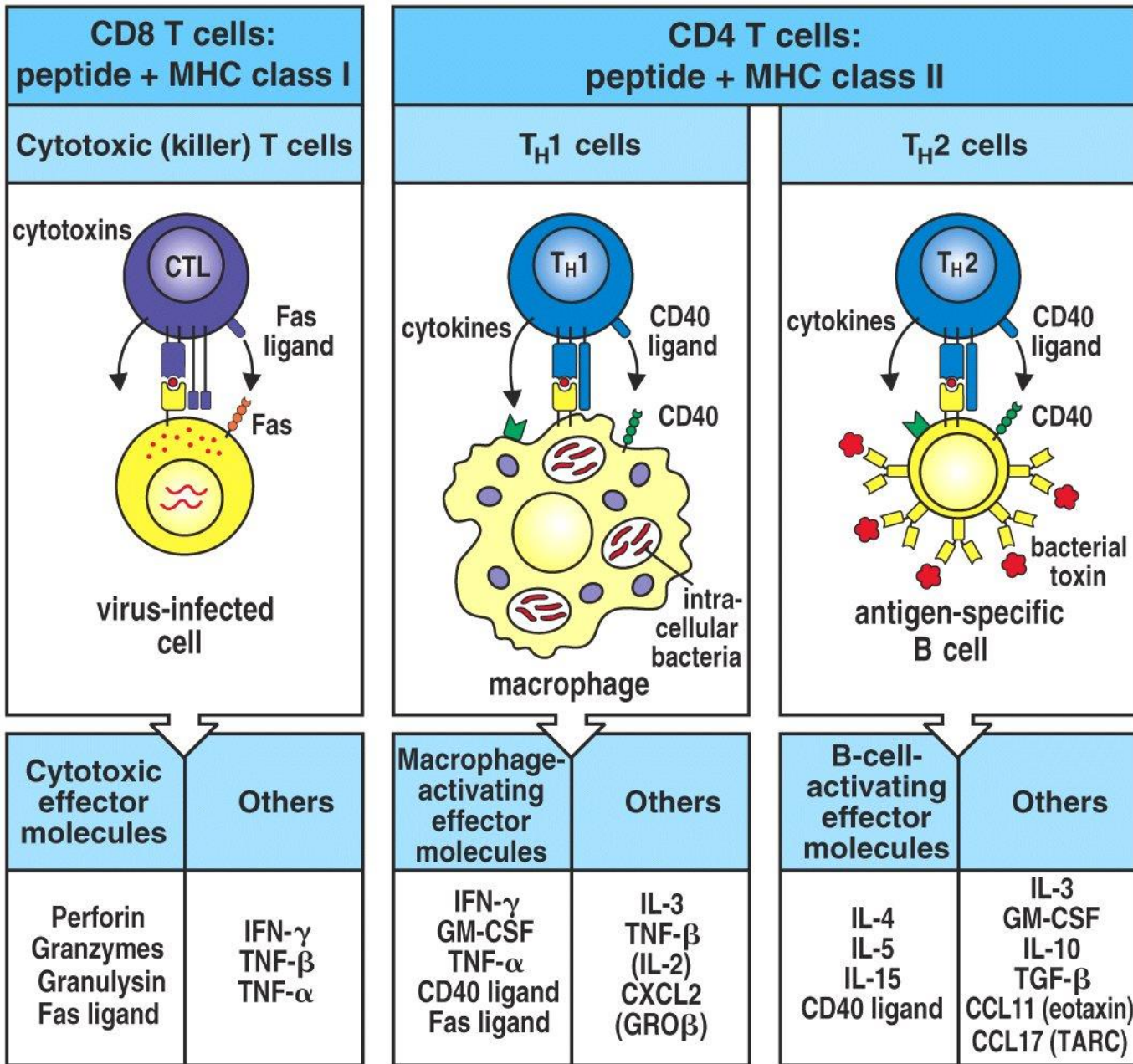

Figure 8-31 Immunobiology, 6/e. (© Garland Science 2005)

SPECIFIC
CLEARANCE
MECHANISMS
FOR PATHOGEN
CLASSES
(KEEP IN MIND
REDUNDANCY)

	Infectious agent	Disease	Humoral immunity				Cell-mediated immunity	
			IgM	IgG	IgE	IgA	CD4 T cells (macrophages)	CD8 killer T cells
Viruses	Variola	Smallpox						
	Varicella zoster	Chickenpox						
	Epstein-Barr virus	Mononucleosis						
	Influenza virus	Influenza						
	Mumps virus	Mumps						
	Measles virus	Measles						
	Polio virus	Poliomyelitis						
	Human immunodeficiency virus	AIDS						
Bacteria	<i>Staphylococcus aureus</i>	Boils						
	<i>Streptococcus pyogenes</i>	Tonsillitis						
	<i>Streptococcus pneumoniae</i>	Pneumonia						
	<i>Neisseria gonorrhoeae</i>	Gonorrhoea						
	<i>Neisseria meningitidis</i>	Meningitis						
	<i>Corynebacterium diphtheriae</i>	Diphtheria						
	<i>Clostridium tetani</i>	Tetanus						
	<i>Treponema pallidum</i>	Syphilis			Transient			
	<i>Borrelia burgdorferi</i>	Lyme disease			Transient			
	<i>Salmonella typhi</i>	Typhoid						
	<i>Vibrio cholerae</i>	Cholera						
	<i>Legionella pneumophila</i>	Legionnaire's disease						
	<i>Rickettsia prowazekii</i>	Typhus						
	<i>Chlamydia trachomatis</i>	Trachoma						
Mycobacteria	Tuberculosis, leprosy							
Fungi	<i>Candida albicans</i>	Candidiasis						
Protozoa	<i>Plasmodium</i> spp.	Malaria						
	<i>Toxoplasma gondii</i>	Toxoplasmosis						
	<i>Trypanosoma</i> spp.	Trypanosomiasis						
	<i>Leishmania</i> spp.	Leishmaniasis						
Worms	Schistosome	Schistosomiasis						

LAST QUESTION?

- When do I shut off?
 - Regulation by specialized cells via direct contact and secreted cytokines
 - Inhibition loops within cells along cytokine cascades
- Multiple mechanisms with diverse consequences
 - Autoimmunity
 - Asthma and allergy



Thymus

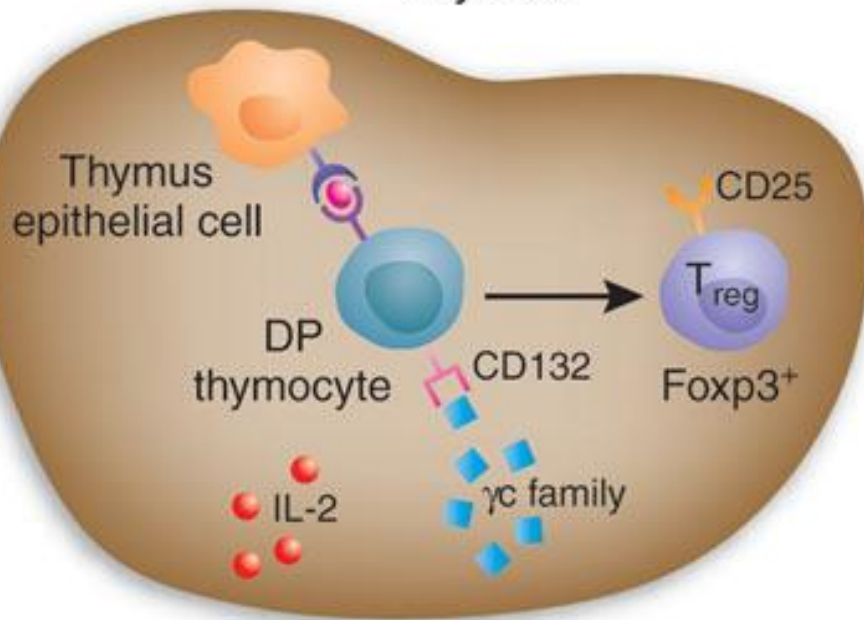

Periphery

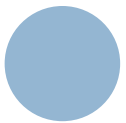
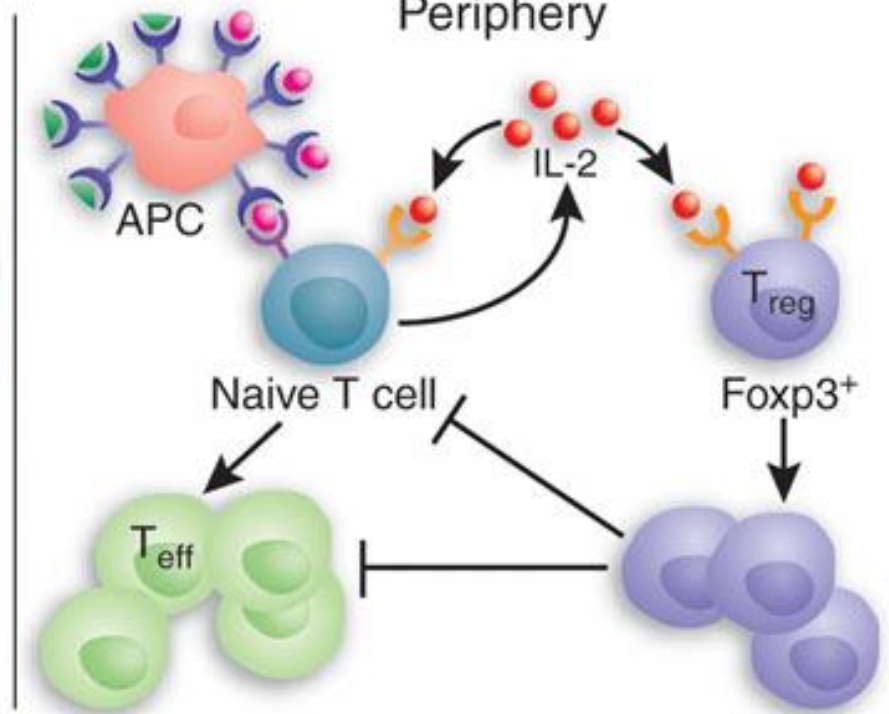

a Inhibitory cytokines

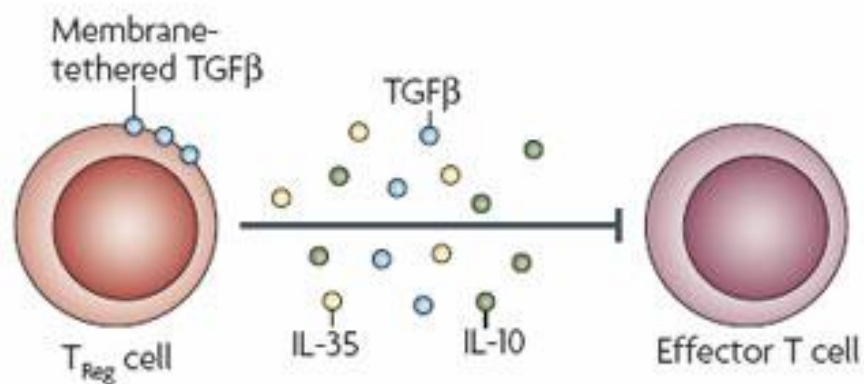

b Cytolysis

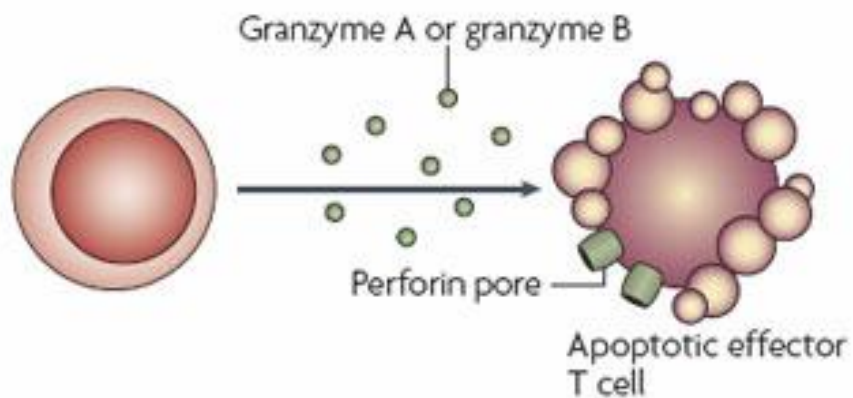

c Metabolic disruption

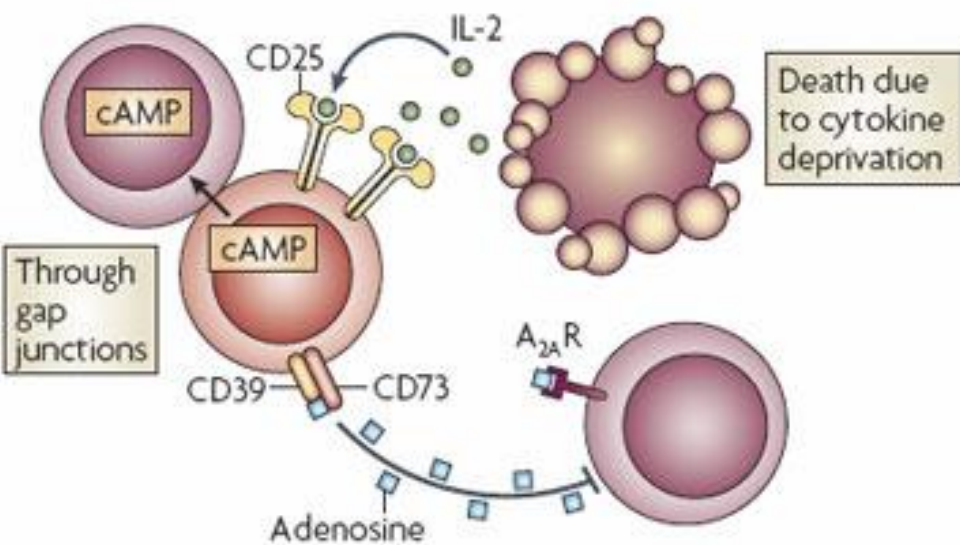

d Targeting dendritic cells

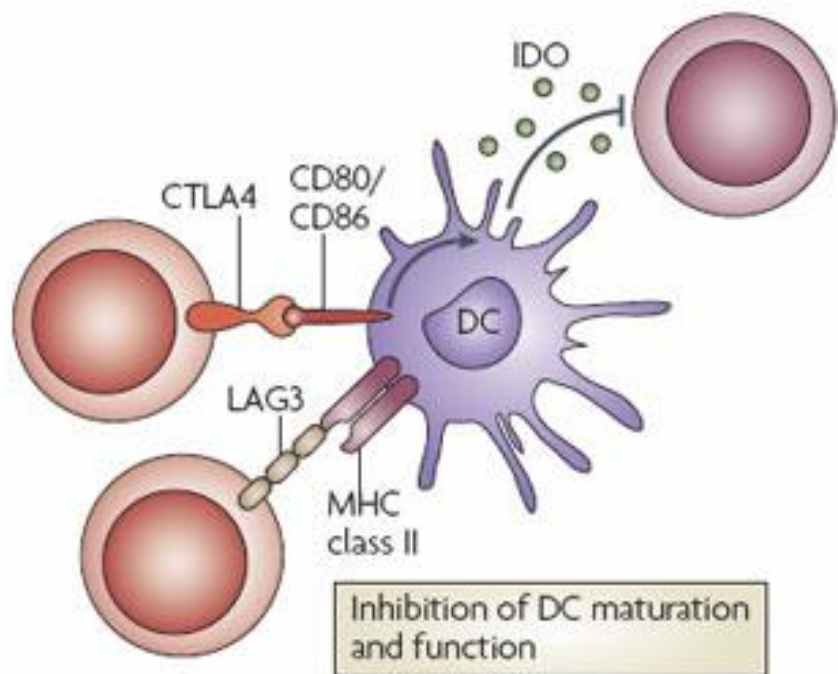

THANKS FOR THE MEMORIES...

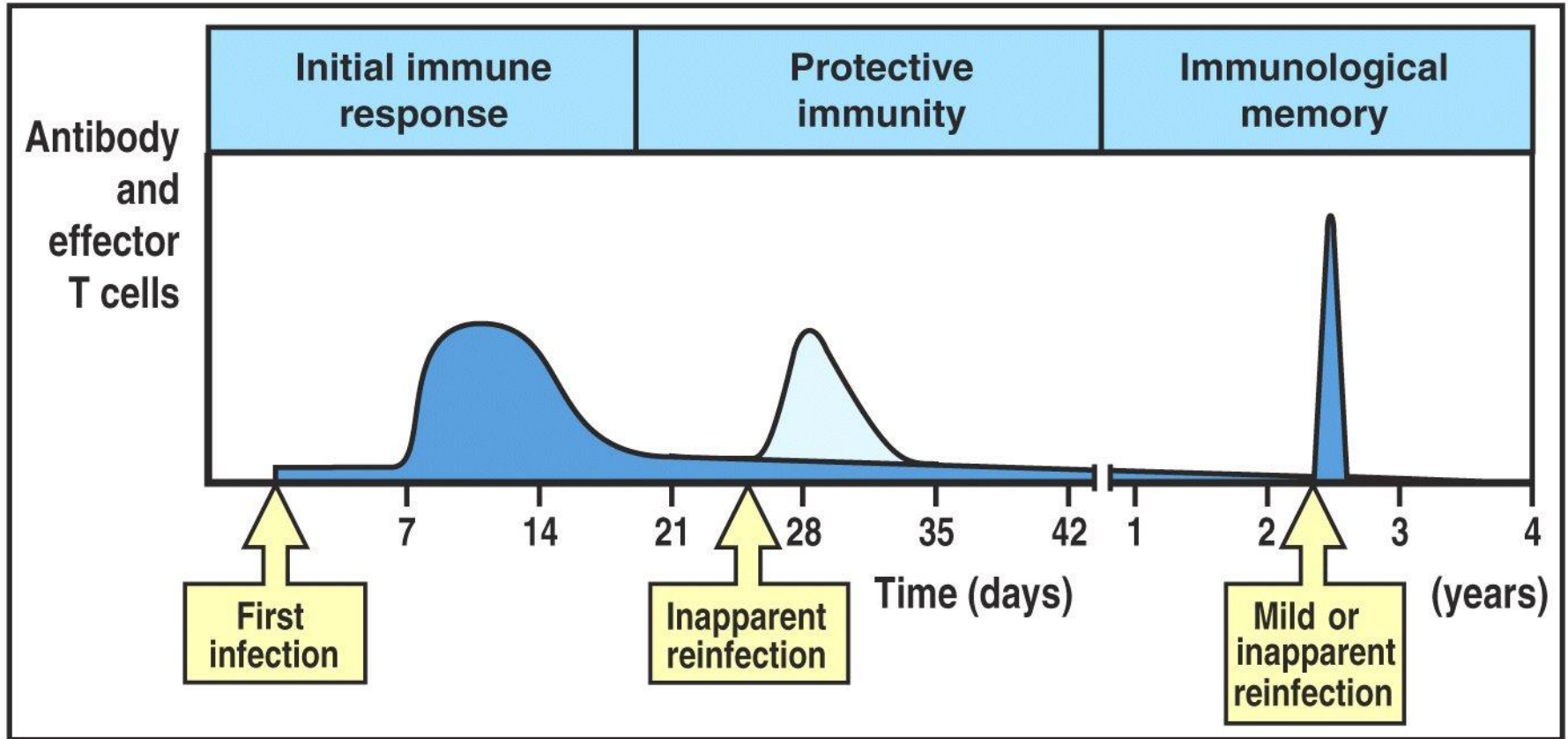
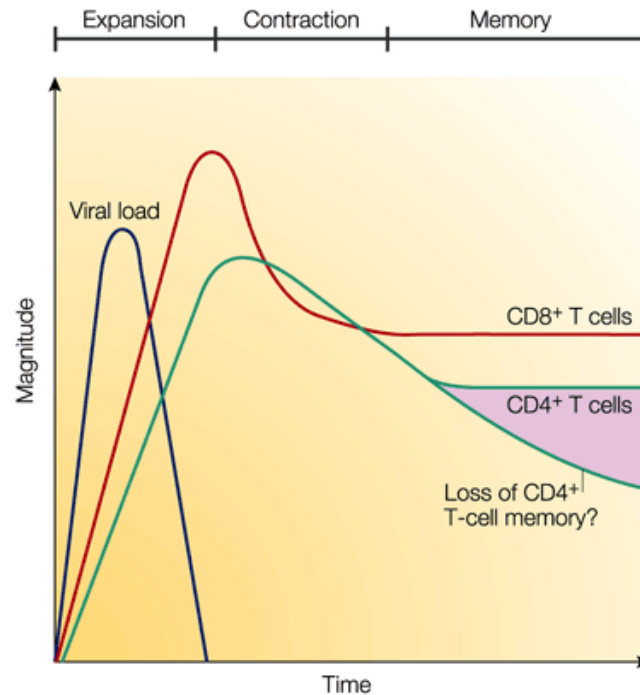

Figure 10-18 Immunobiology, 6/e. (© Garland Science 2005)

MEMORY

- After contraction, memory CD8 numbers are maintained (active process) while CD4 cells slowly decline
- Higher precursor numbers are a key feature of memory
- Memory cells more rapidly acquire effector function and have lower thresholds of activation



Innate immunity
(rapid response)

Adaptive immunity
(slow response)

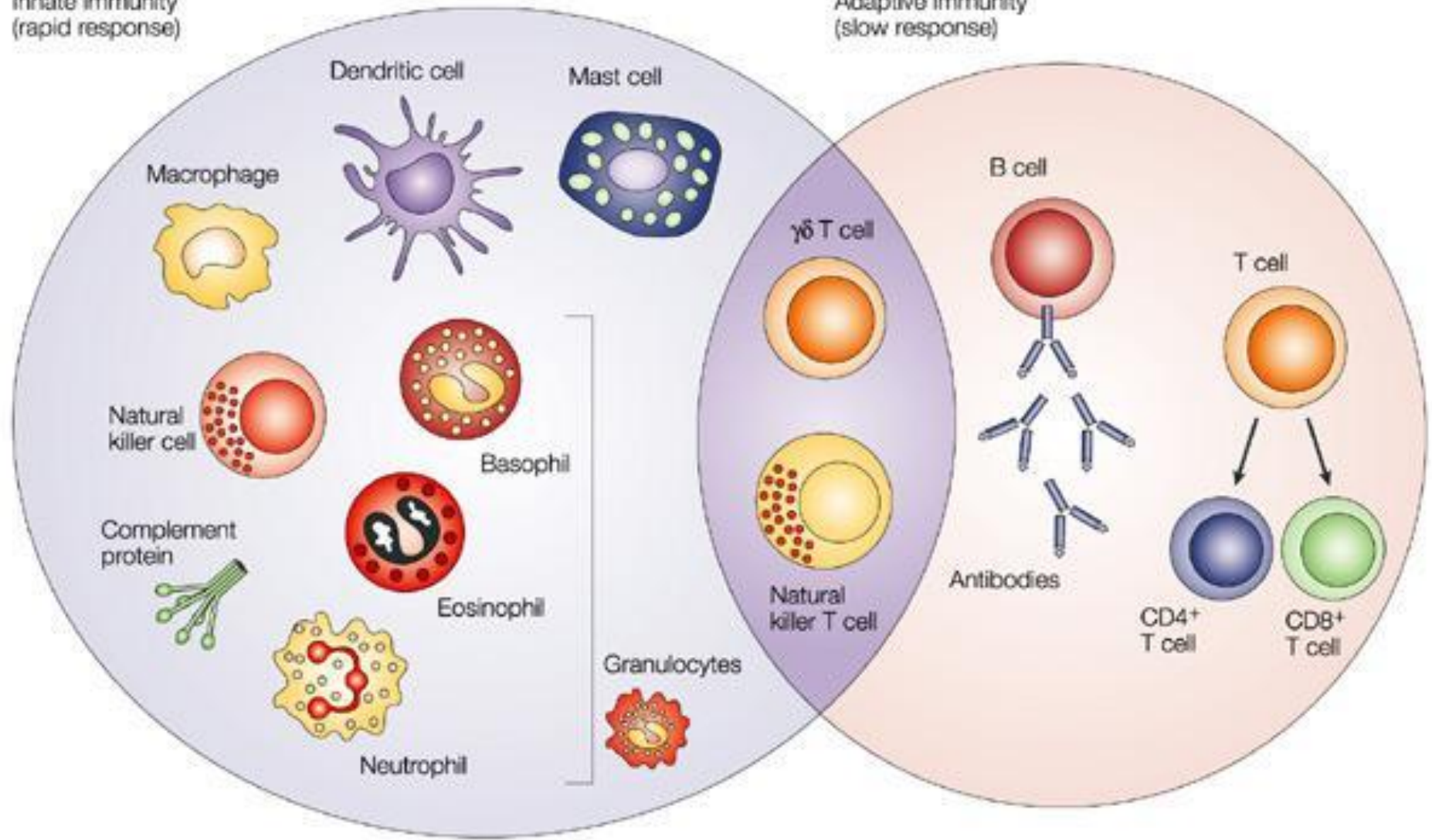

EVOLUTIONARY DEVELOPMENT OF IMMUNITY

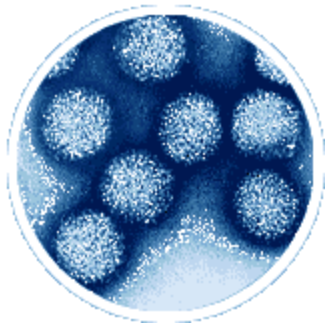

Viruses (~0.2 microns)

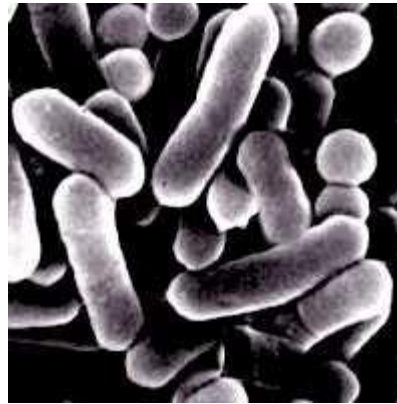

Bacteria (1-2 microns)



Parasites (Millimeters)

